

_____’s

Kinder Ready Workbook

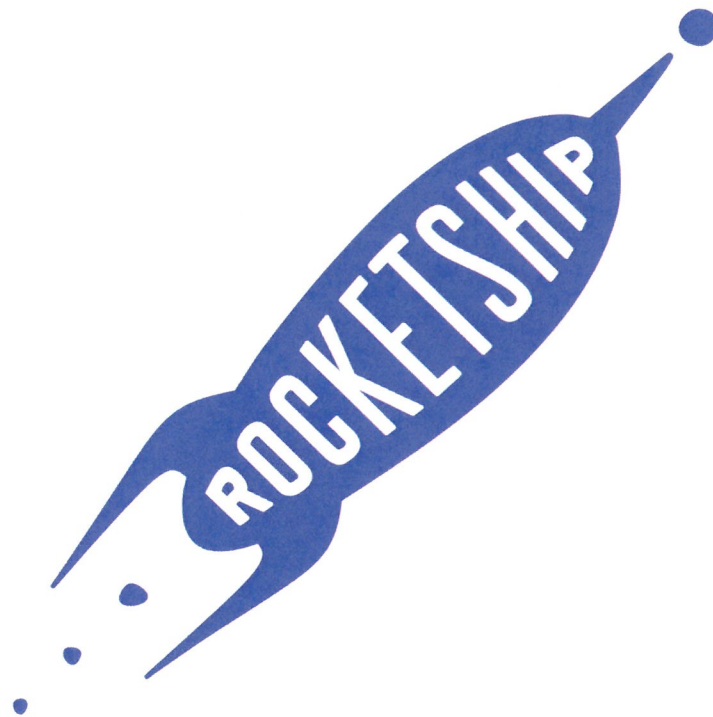

March

ROCKETSHIP
PUBLIC SCHOOLS



Parent Instructions

This workbook will help your student with their letter names and sounds! They will need your help to read the instructions.

When your student is writing their letters, make sure they start each letter from the top and lifting their pencil when they reach the bottom.

It can be helpful to have them trace the letter with their finger on the paper or in the air before they write, so they can practice the lines!

Students can start to practice holding their pencil with a tripod grip. This means their thumb is on the bottom and they are “pinching” the pencil with their fingers.

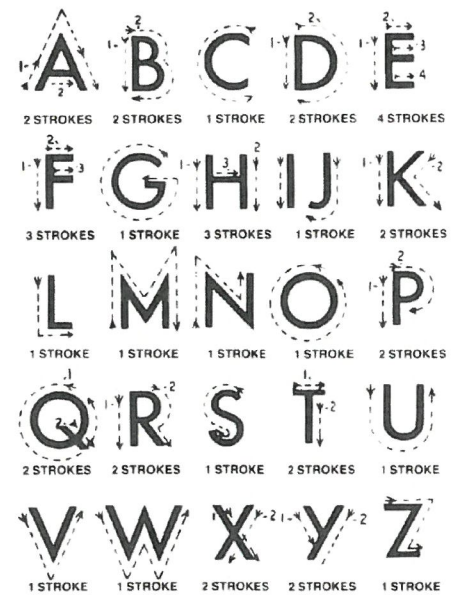

The dotted lines indicate the DIRECTION and SEQUENCE of strokes to be made on the palm.

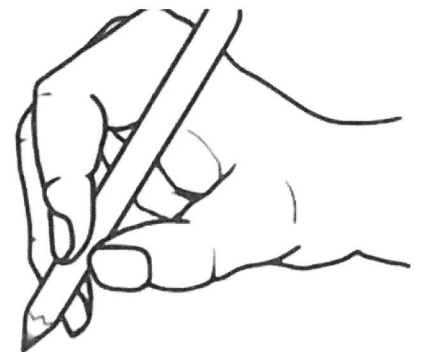

Thank you for your partnership in your student's learning!
We are excited to have you with us!

Week One:

Aa

1, 2, 3

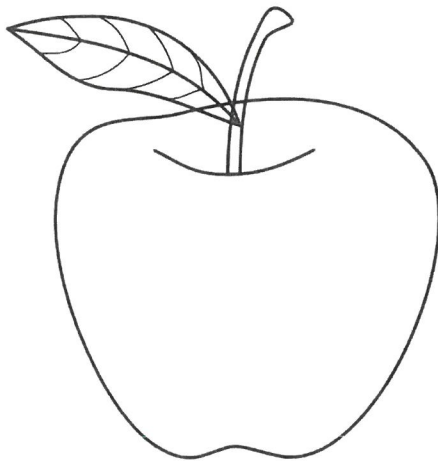

Aa

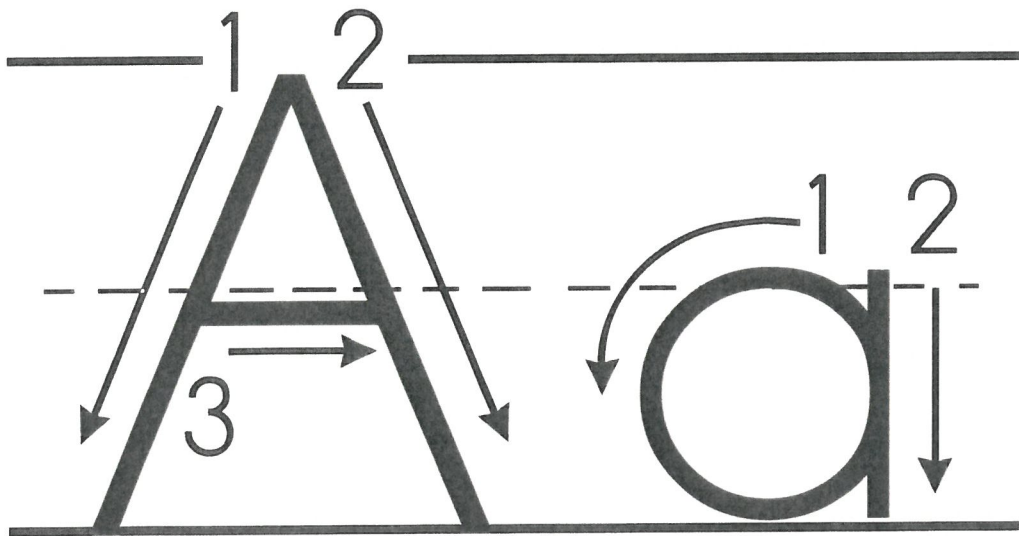
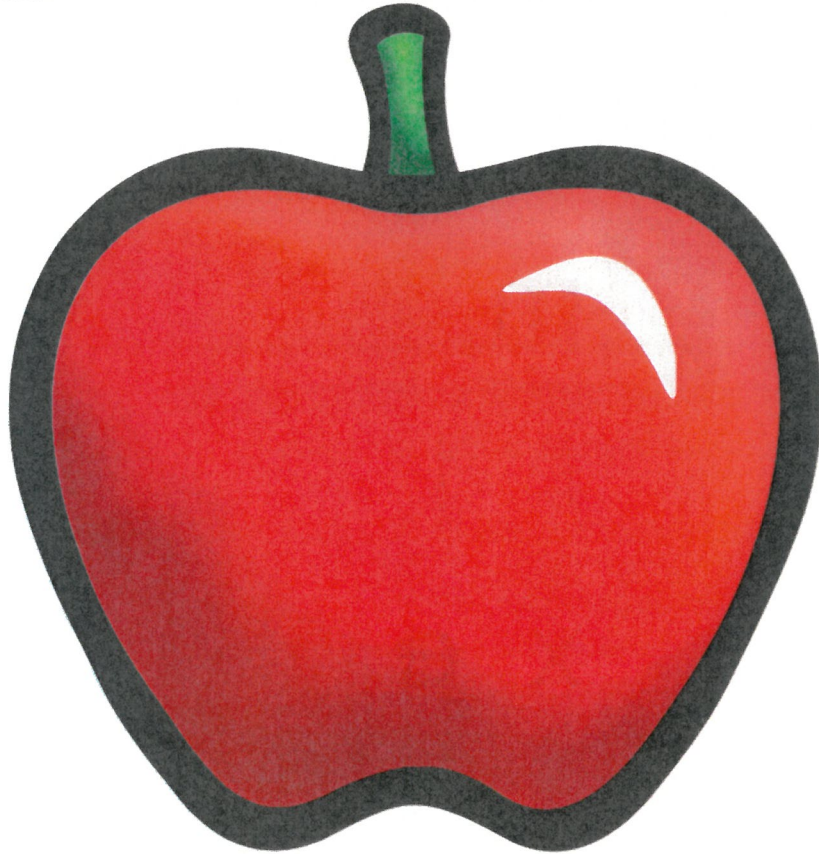

Aa



a t



a m

a n t

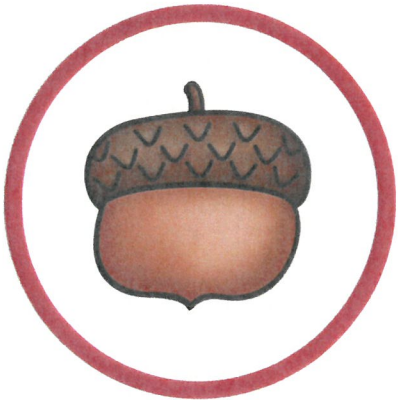

a x e

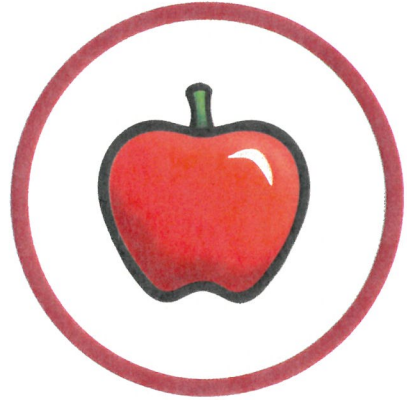

a c o r n

a n g e l



a p p l e

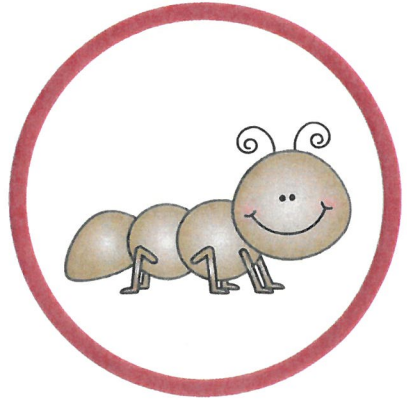

a r r o w

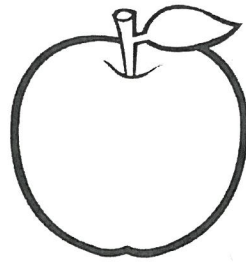
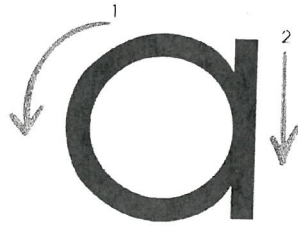
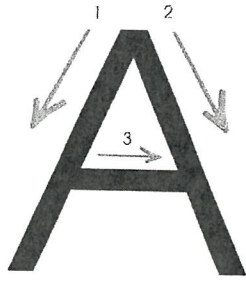

Apple

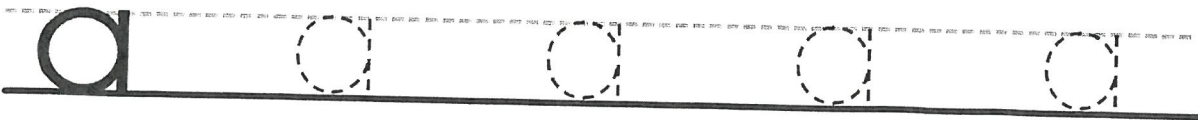
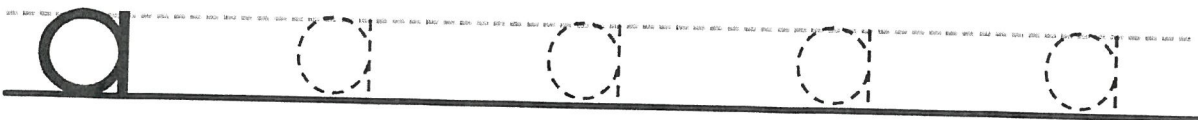
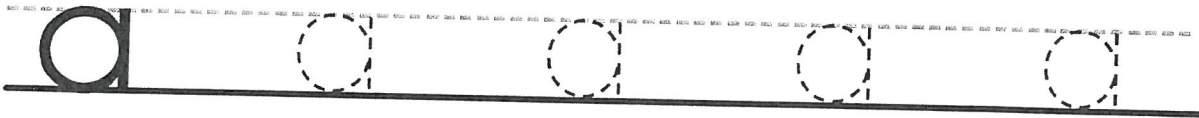
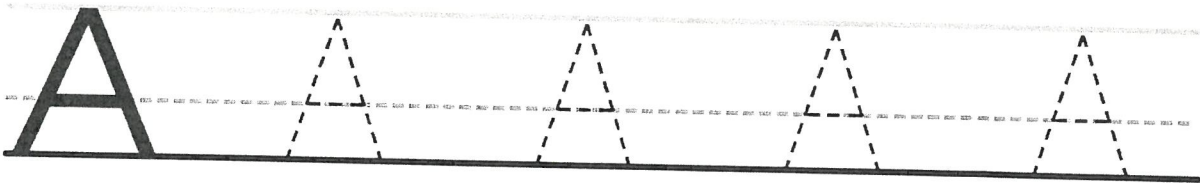
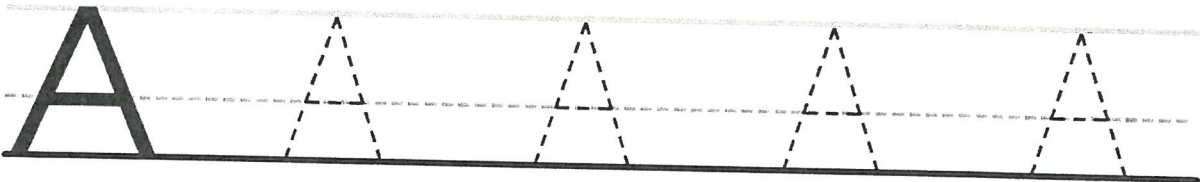
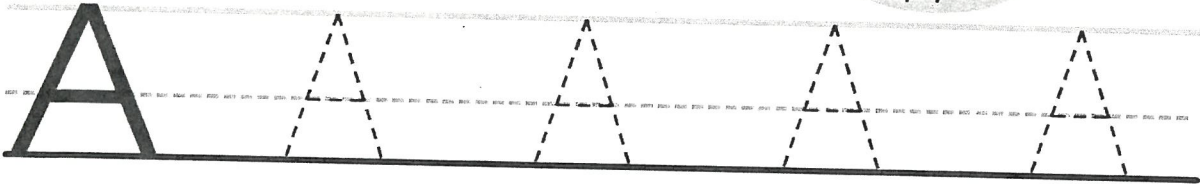

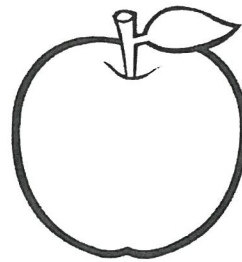
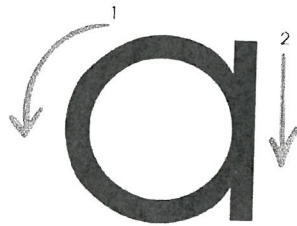
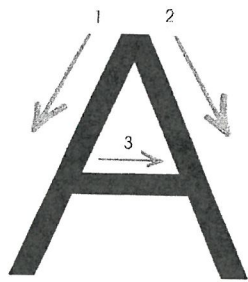

Apple

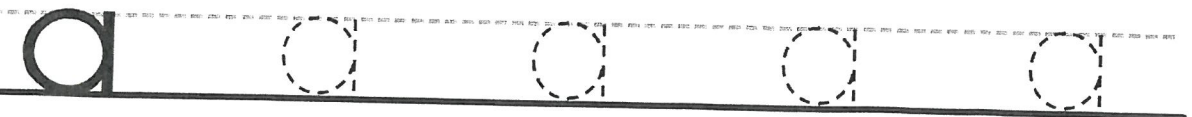
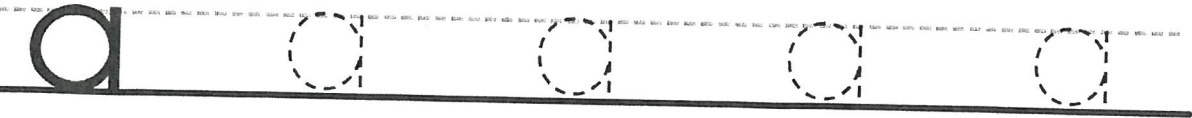
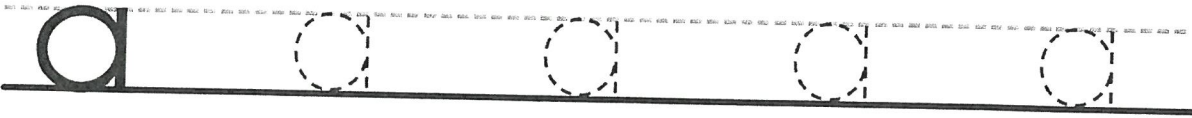
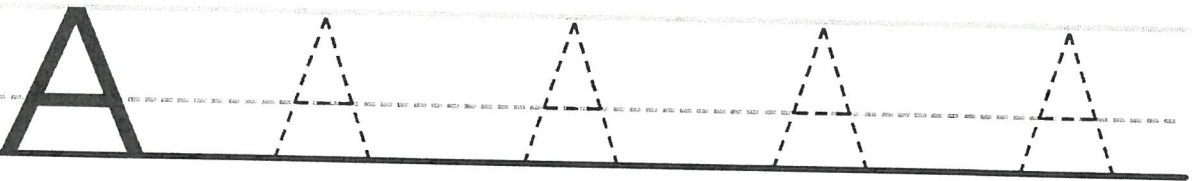
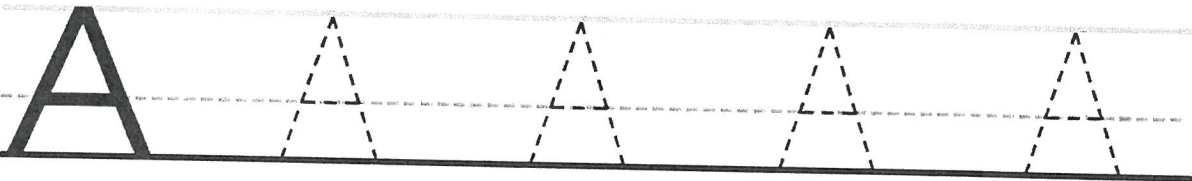
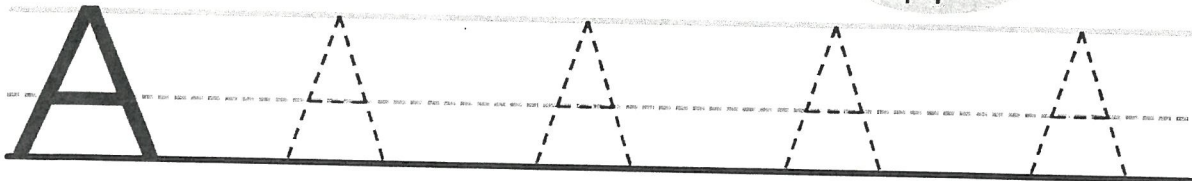

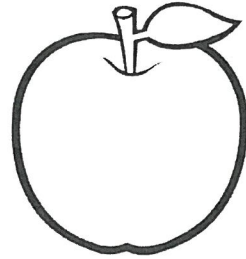
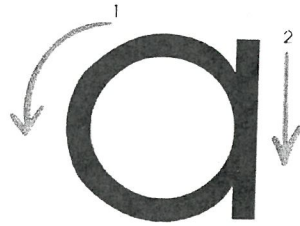
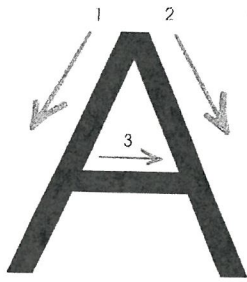

Apple

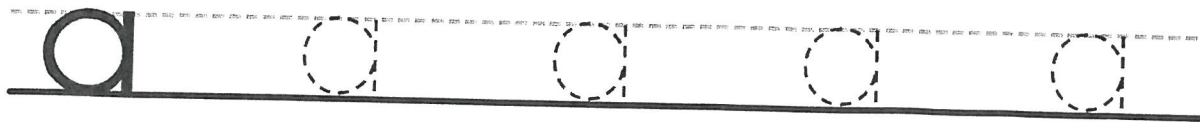
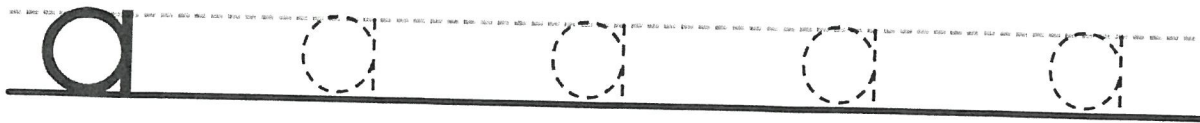
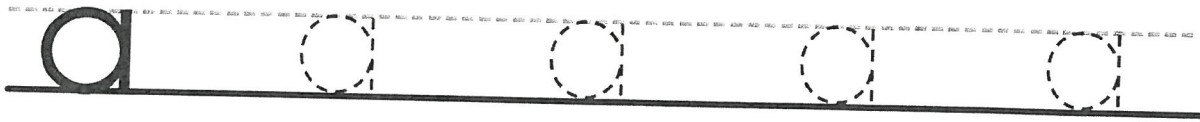
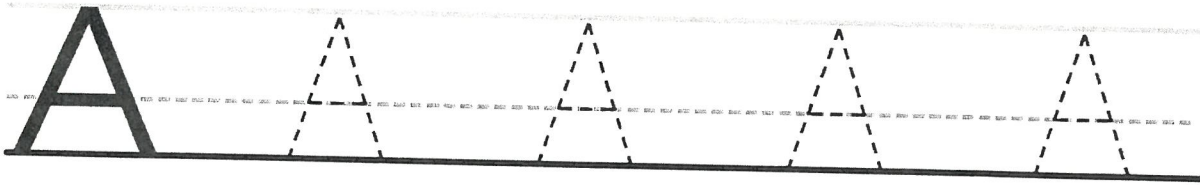
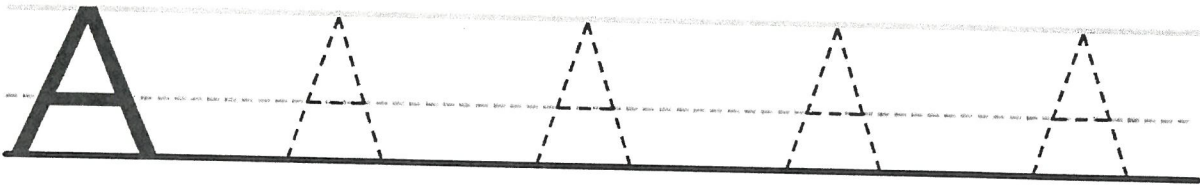
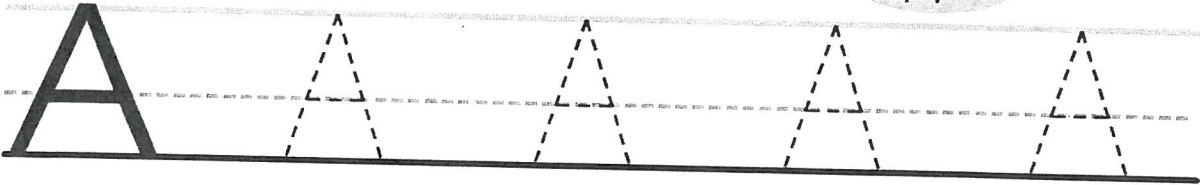

I name:

MATCH THE LETTER











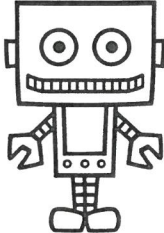

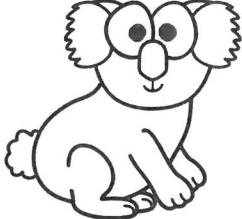
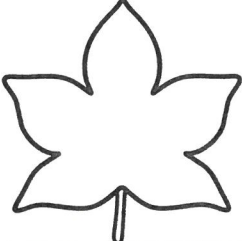
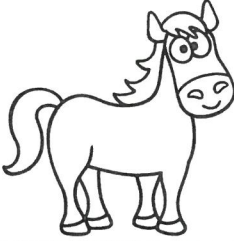

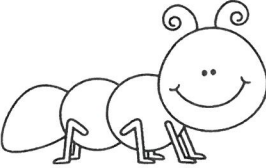
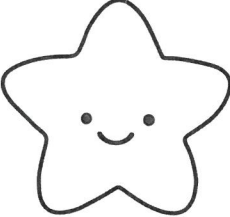
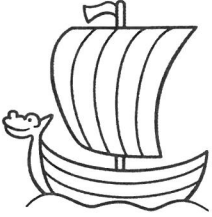
For each row circle the matching letter.

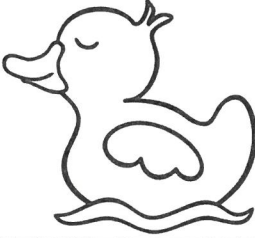
a	f	a	i	w
A	A	K	T	B
a	f	r	i	a
A	E	O	M	A
a	a	s	l	c
A	R	Y	A	Q

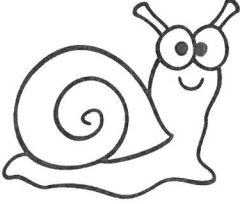
I name:

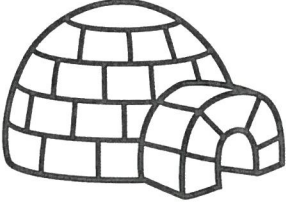
MATCH THE SOUND

For each row color the picture to match the beginning sound.

a			
a			
a			
a			
a			
a			

I name:

BUILD LETTER Aa WORDS

Cut and paste the letter a to complete each word.

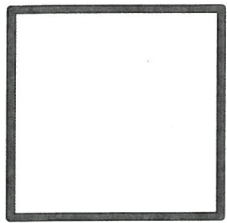

pple

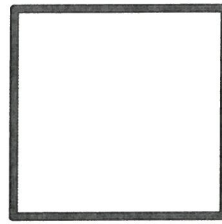

ngel

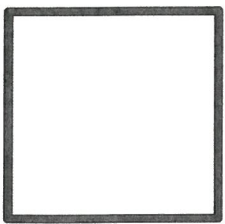

xe

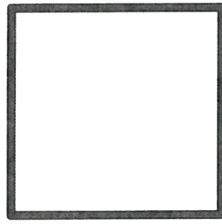

nchor

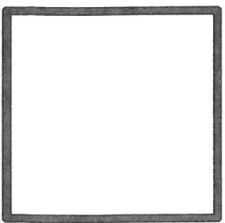
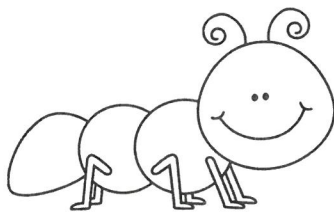

nt

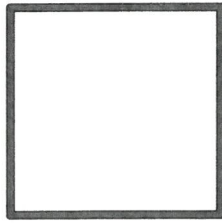
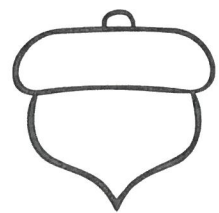

corn

Name _____

Let's warm up!

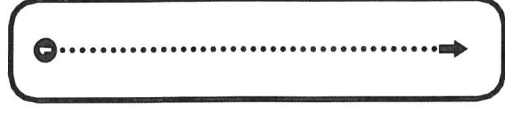
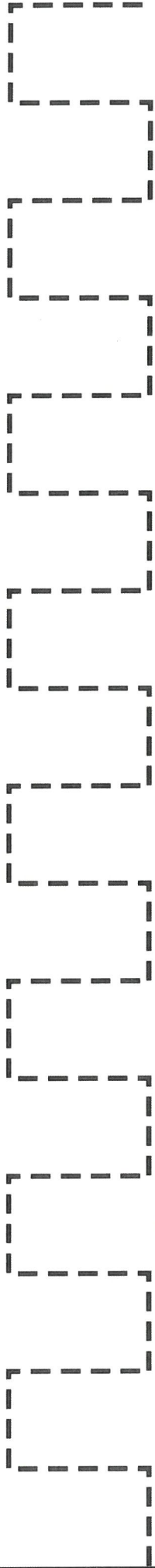
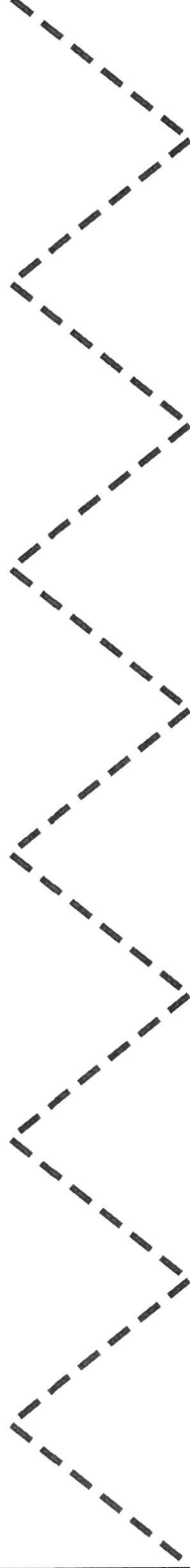

Let's trace the number!

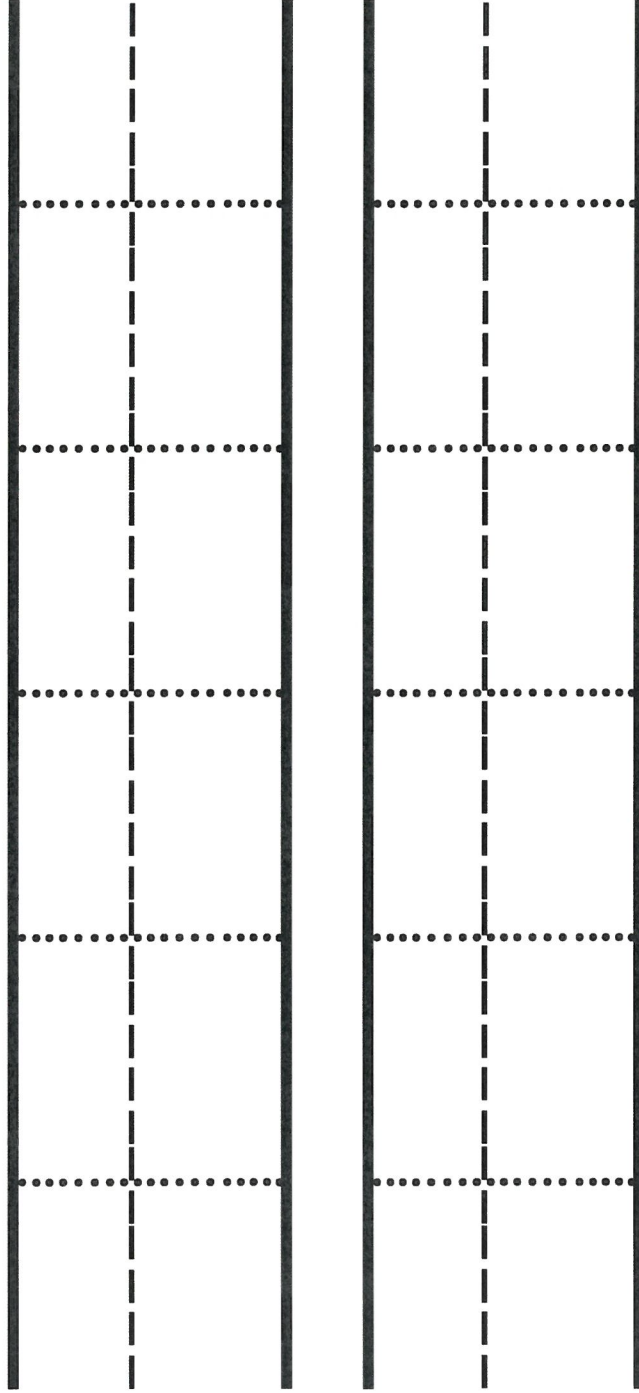

Let's Draw!

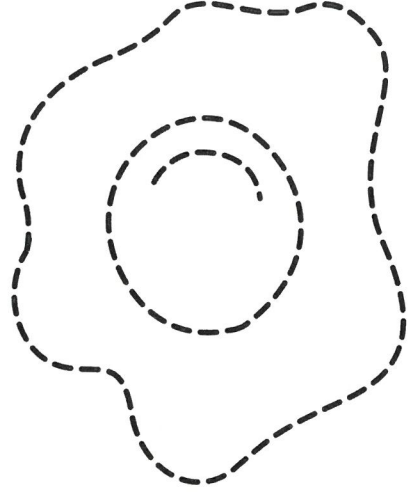

one egg

Name _____

Let's warm up!

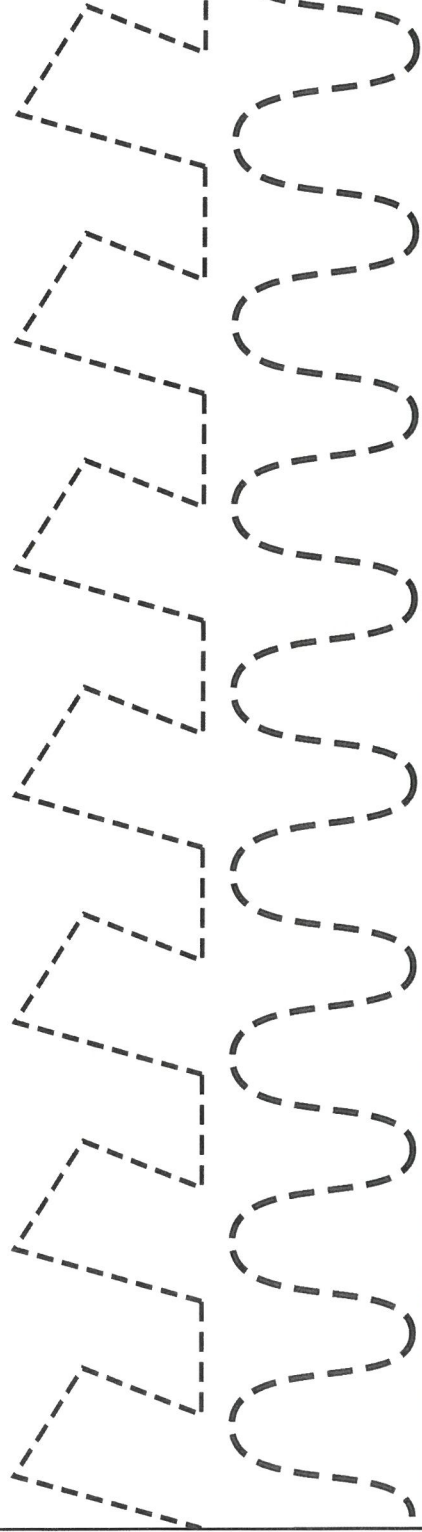

Let's trace the number!

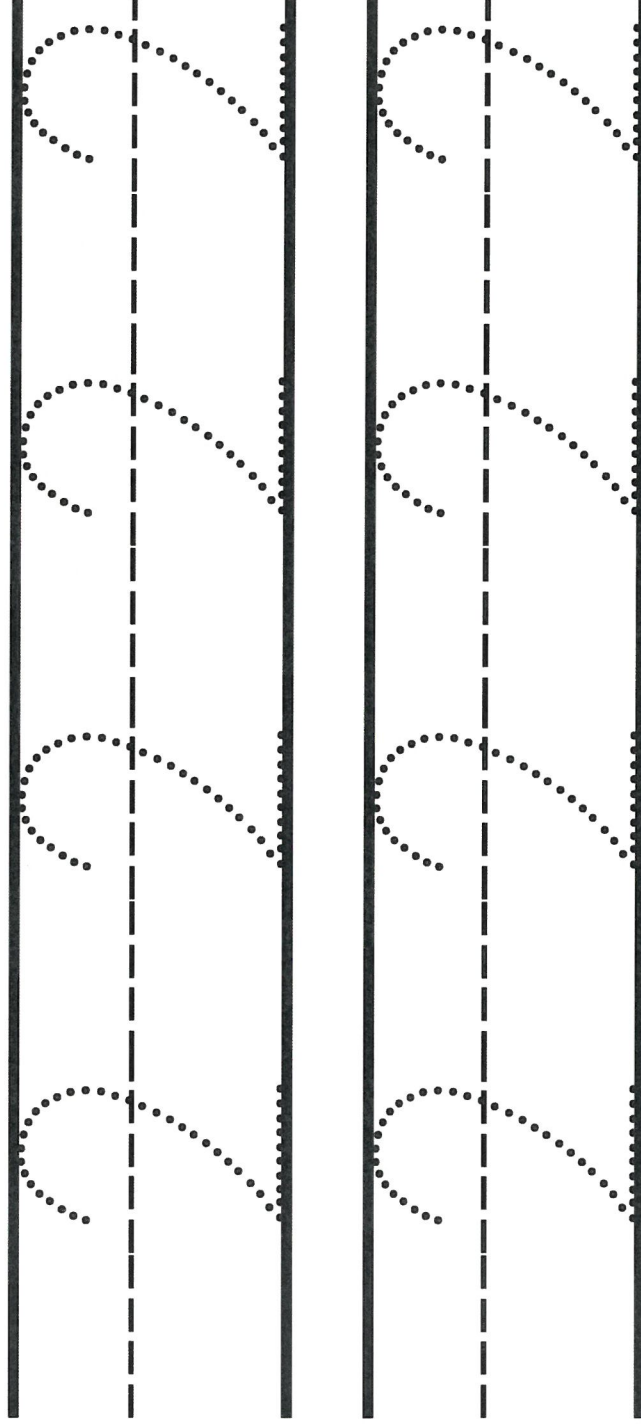

Let's Draw!

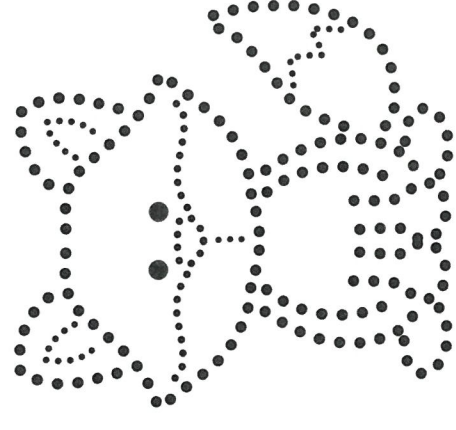

two eyes

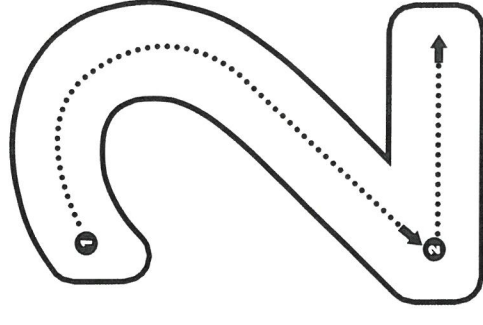

Name _____

Let's warm up!

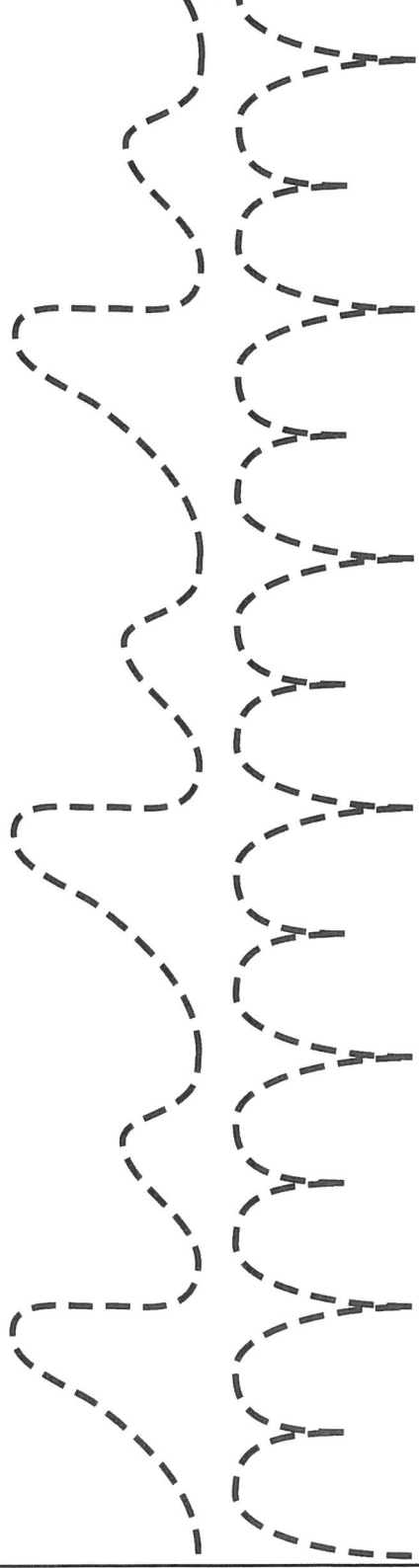

Let's trace the number!

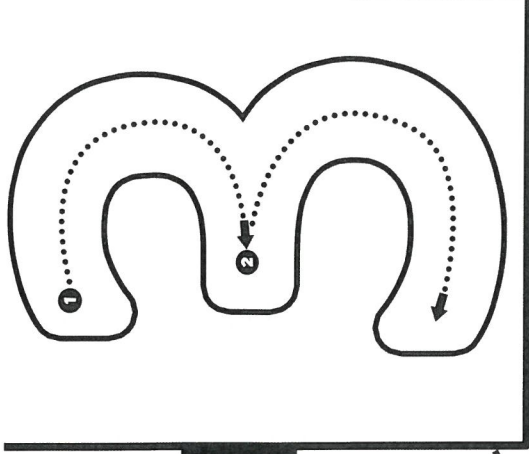
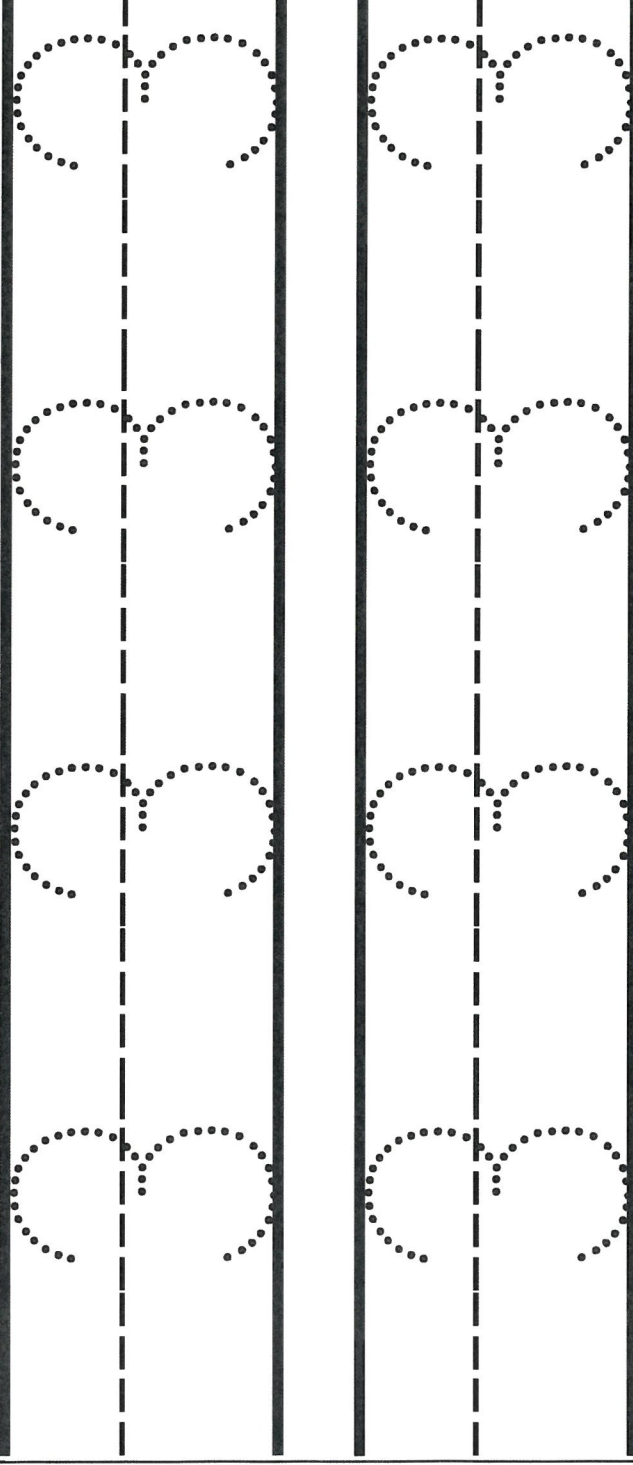

Let's Draw!

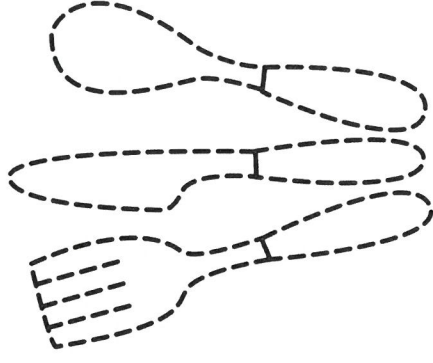

three
utensils

Find the word that rhymes!

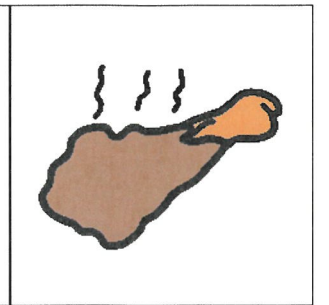
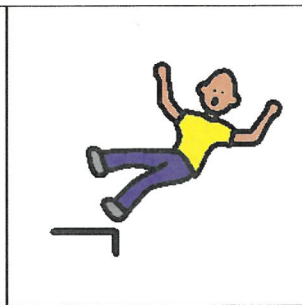
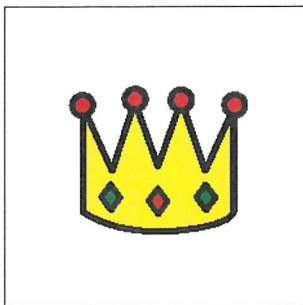
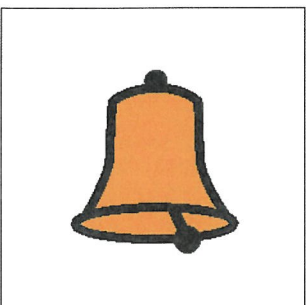
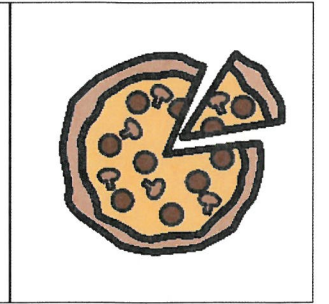
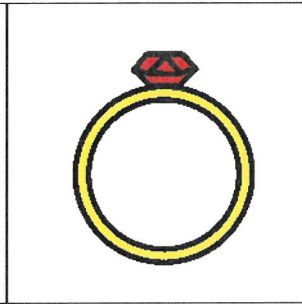
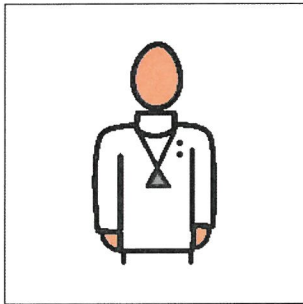
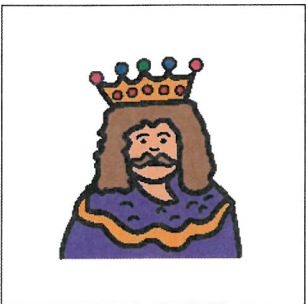
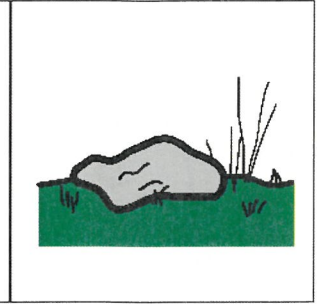
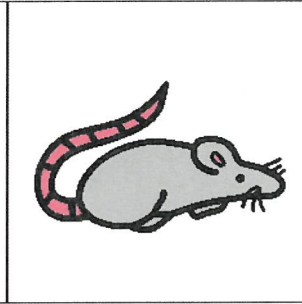
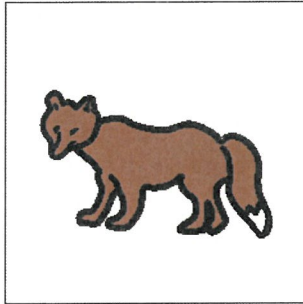
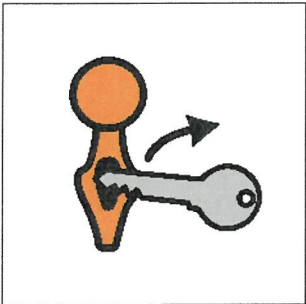
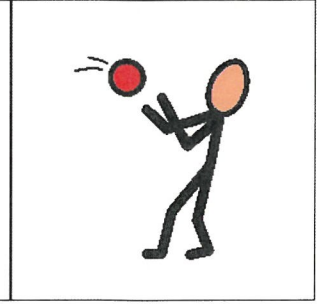
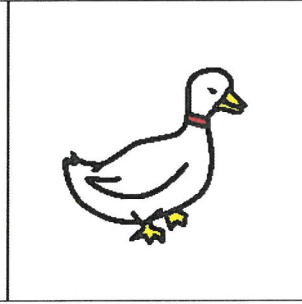
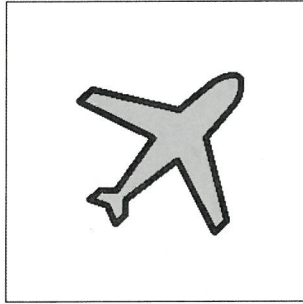
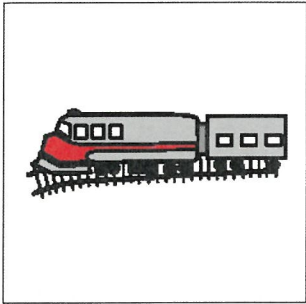
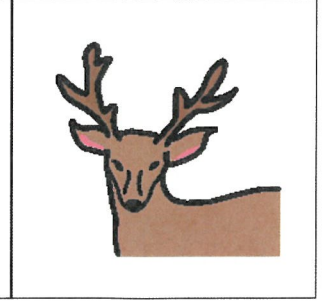
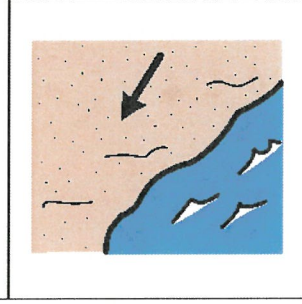
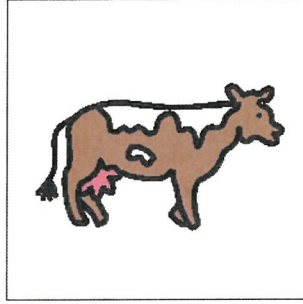
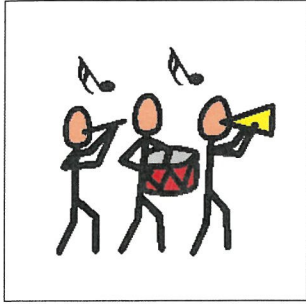

Week Two:

Bb & Cc

4, 5

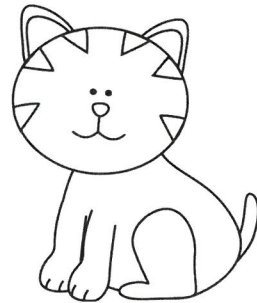
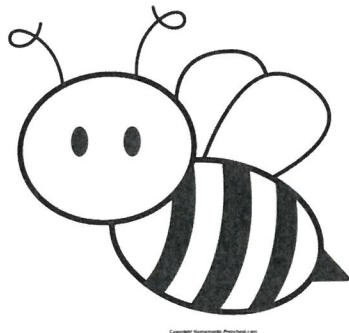

Bb

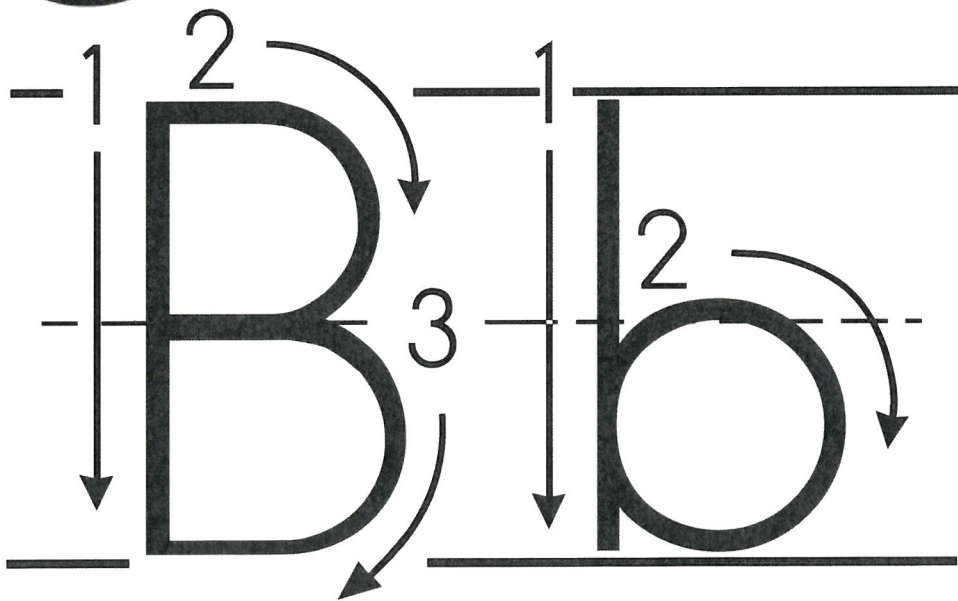
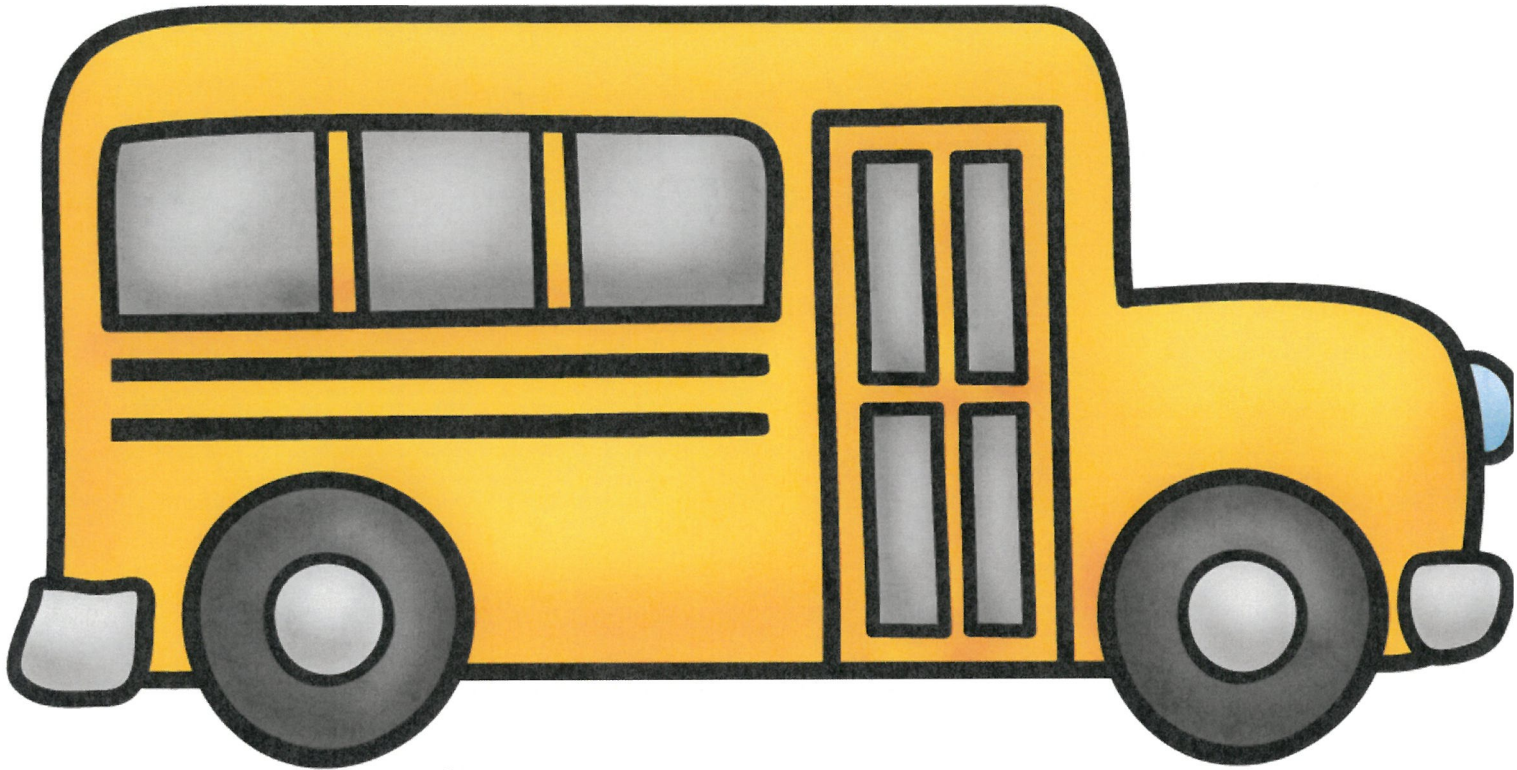

Bb

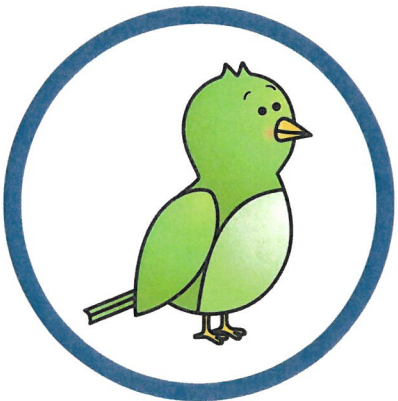
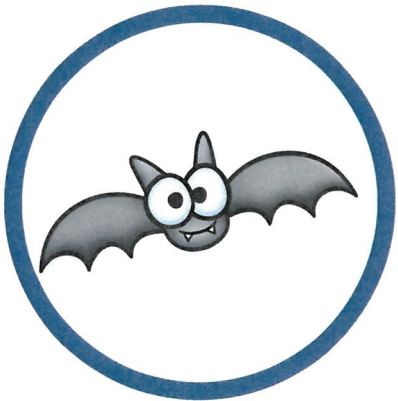
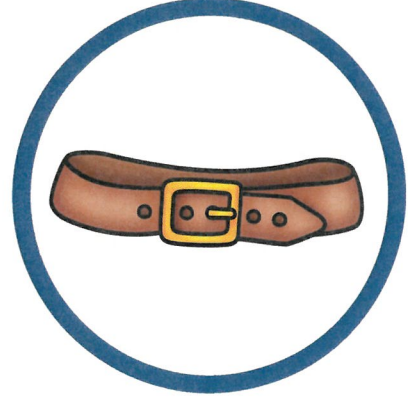

b a t
b u n
b u s
b a k e
b e l l
b e l t
b i r d
b o a t

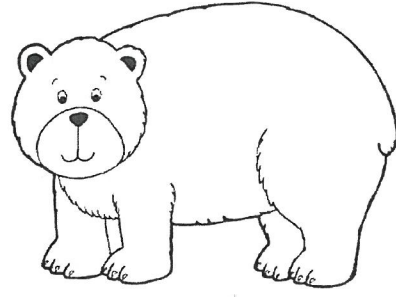
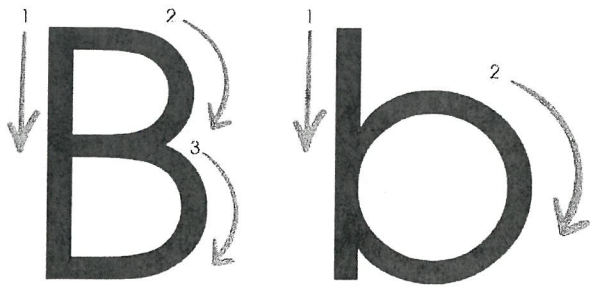

Bear

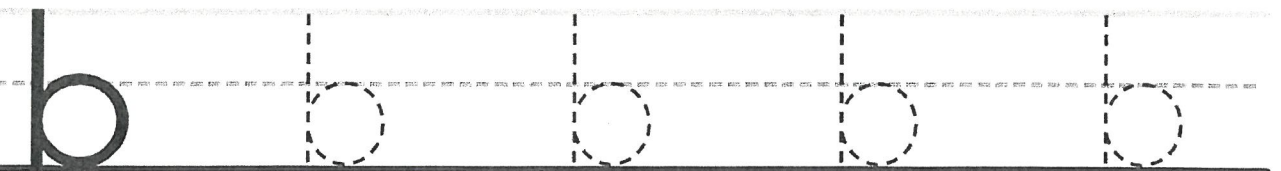
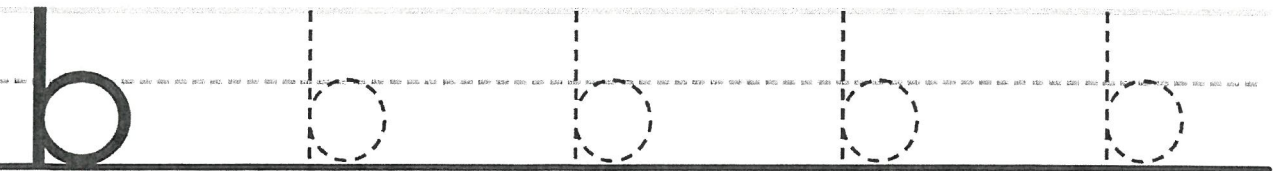
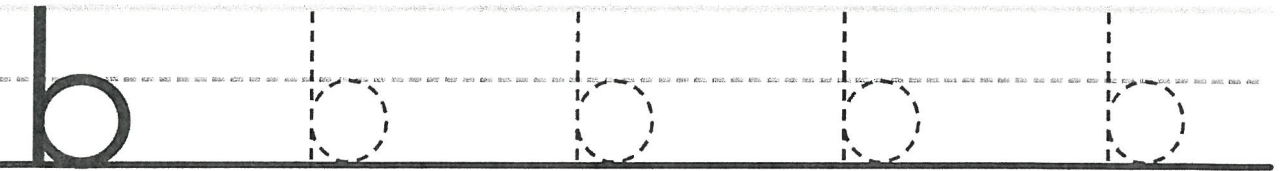
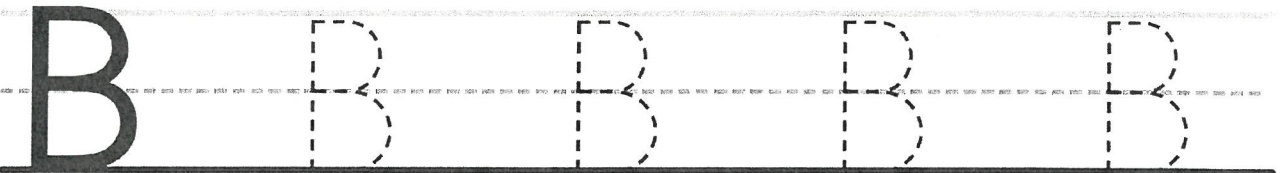
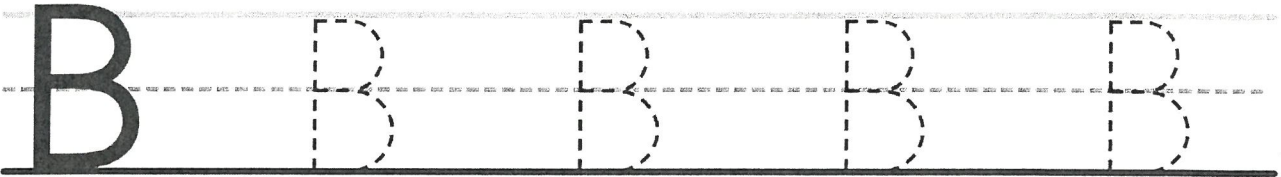
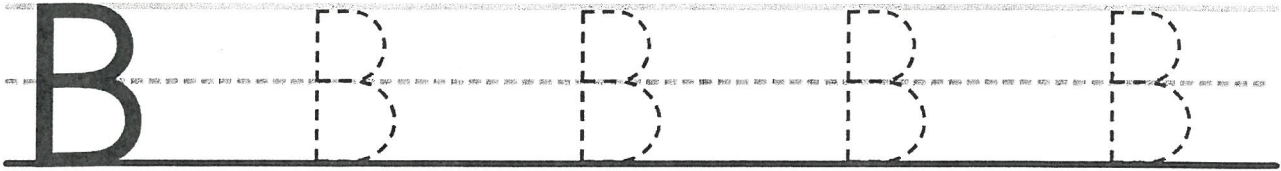

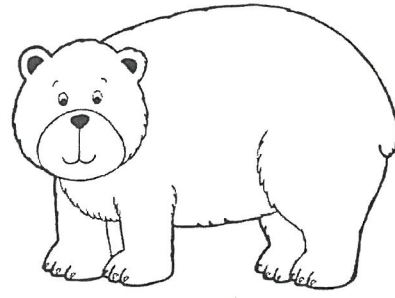
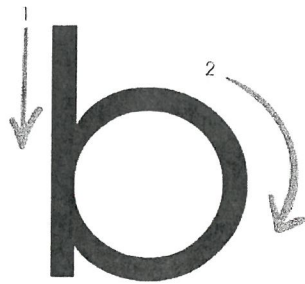
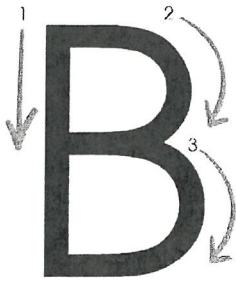

Bear

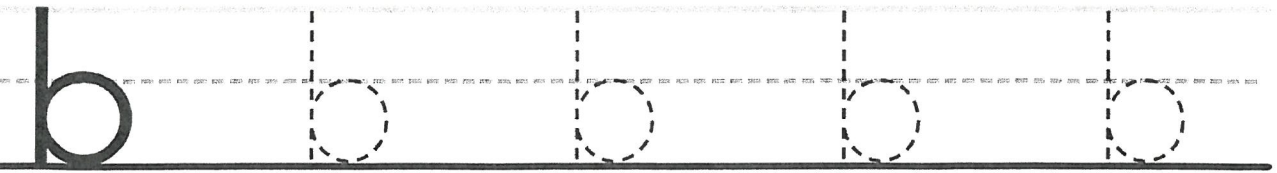
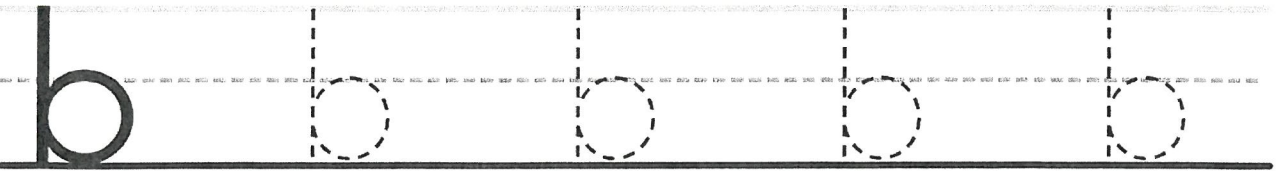
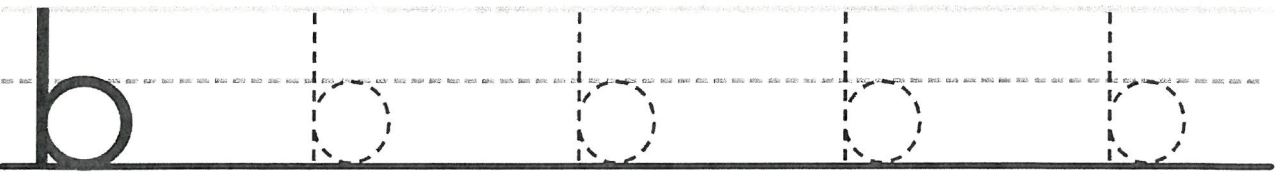
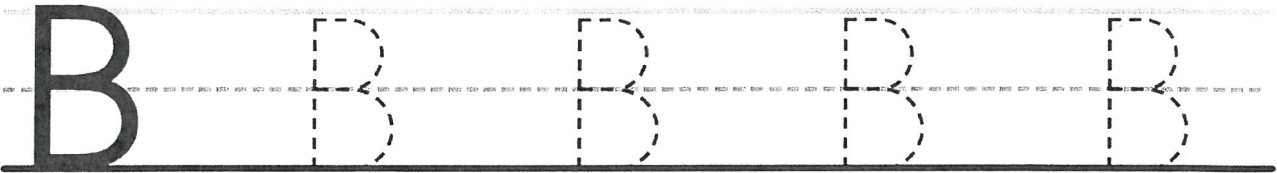
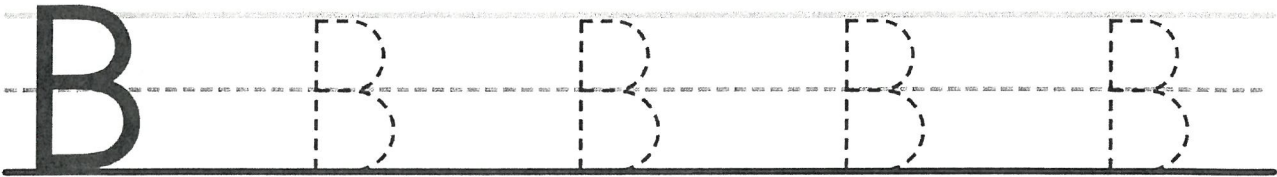
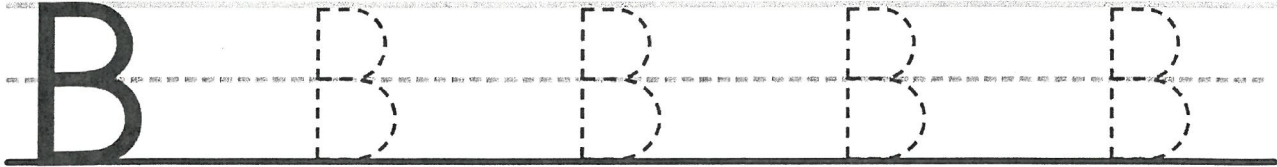

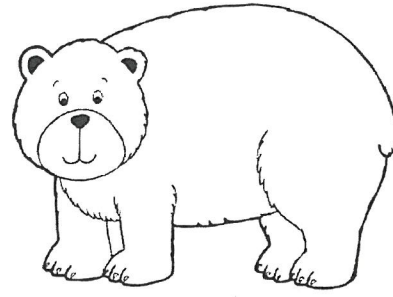
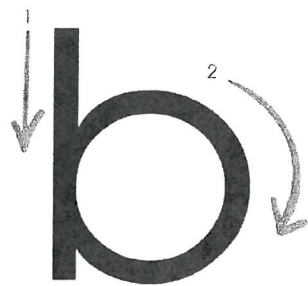
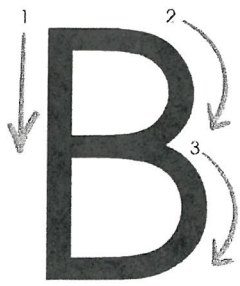

Bear

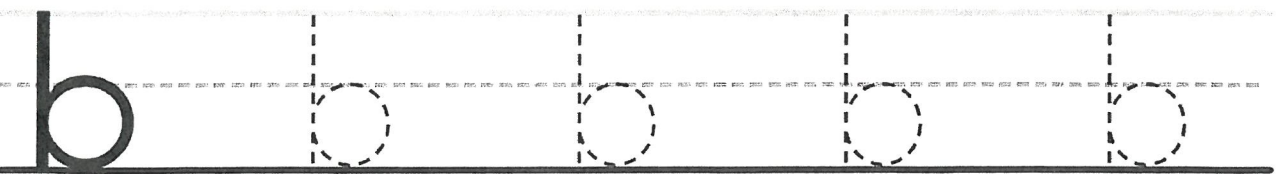
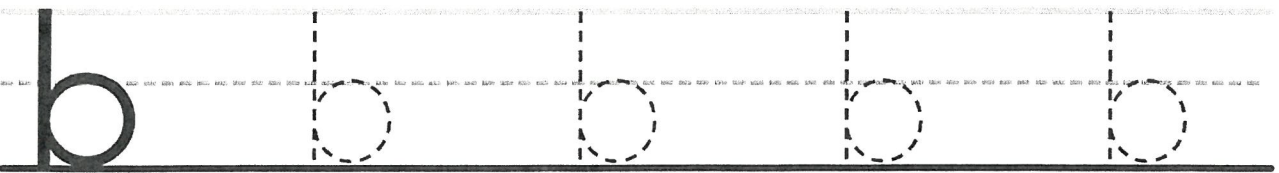
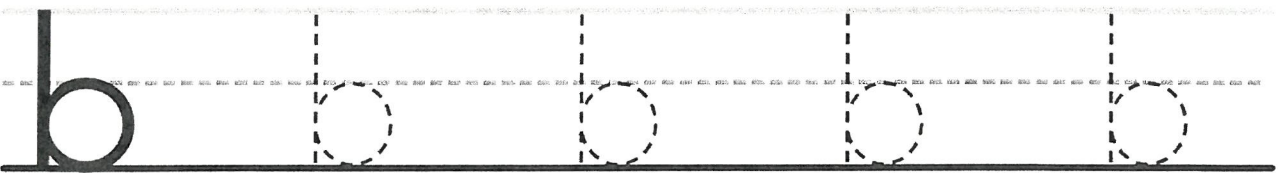
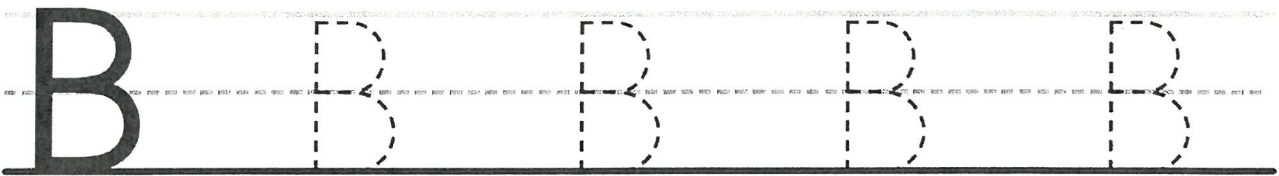
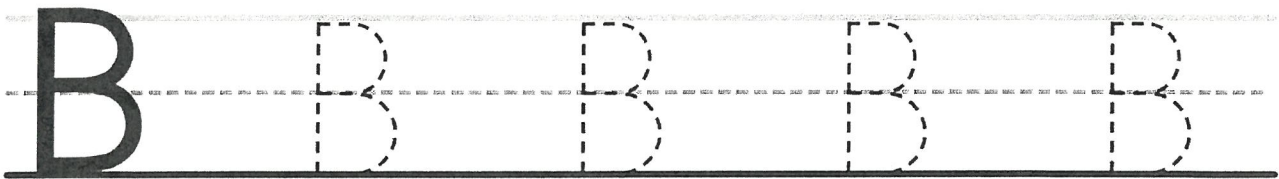
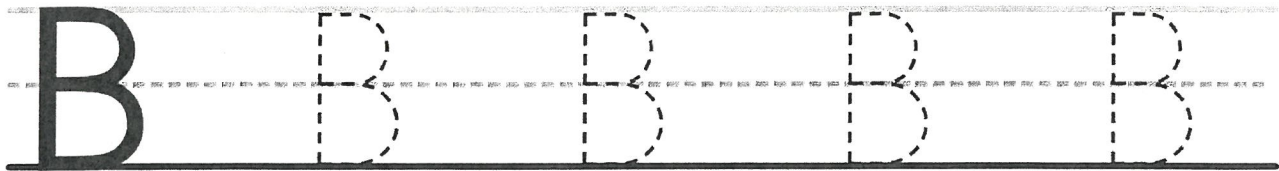

I name:

MATCH THE LETTER











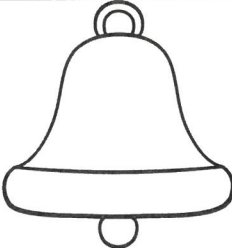
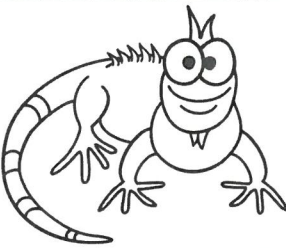
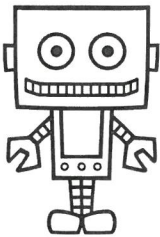

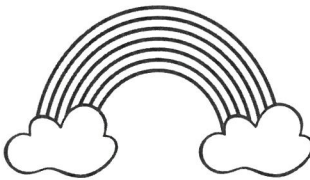
For each row circle the matching letter.

b	e	b	k	s
B	B	L	I	W
b	t	a	n	b
B	V	B	D	N
b	j	f	b	p
B	T	A	B	H

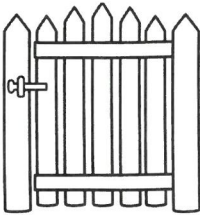
I name:

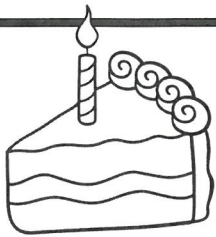
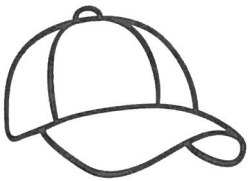
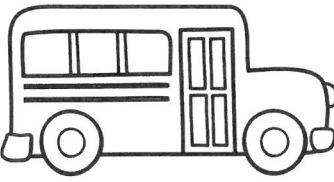
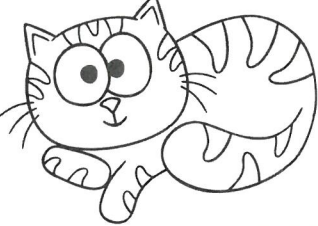
MATCH THE SOUND

For each row color the picture to match the beginning sound.

b			
b			
b			
b			
b			
b			

I name:

BUILD LETTER Bb WORDS

Cut and paste the letter b to complete each word.

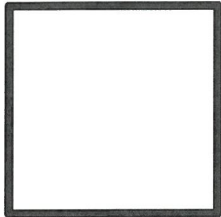
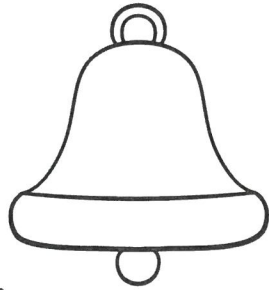

ell

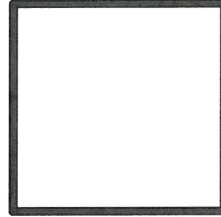
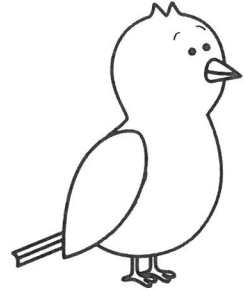

ird

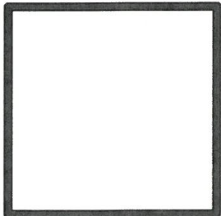
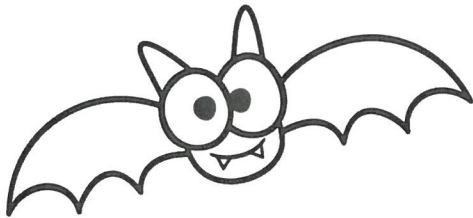

at

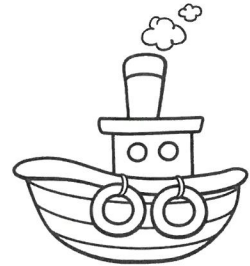

oat

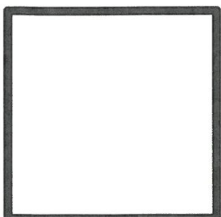
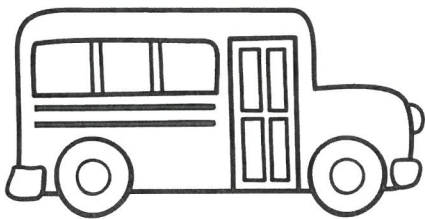

us



oot

Cc

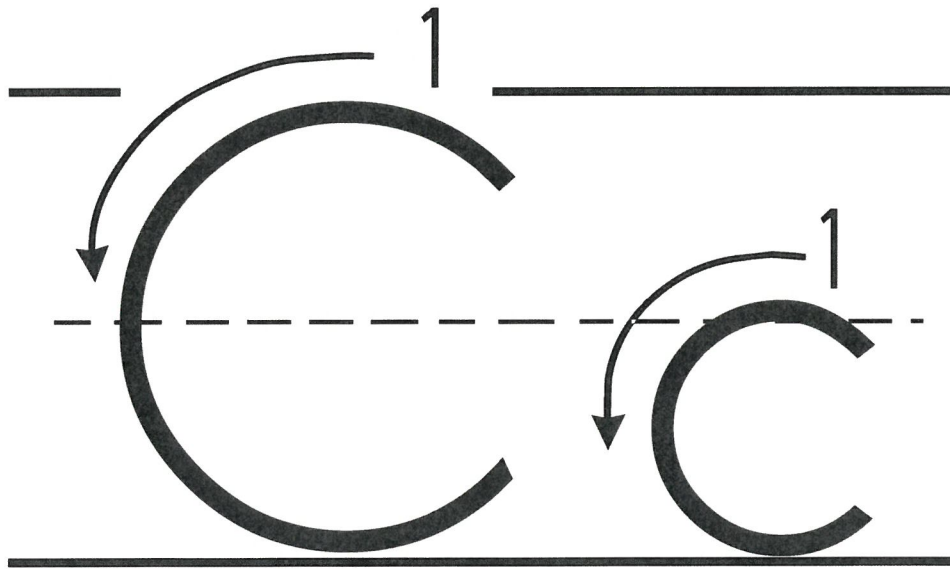
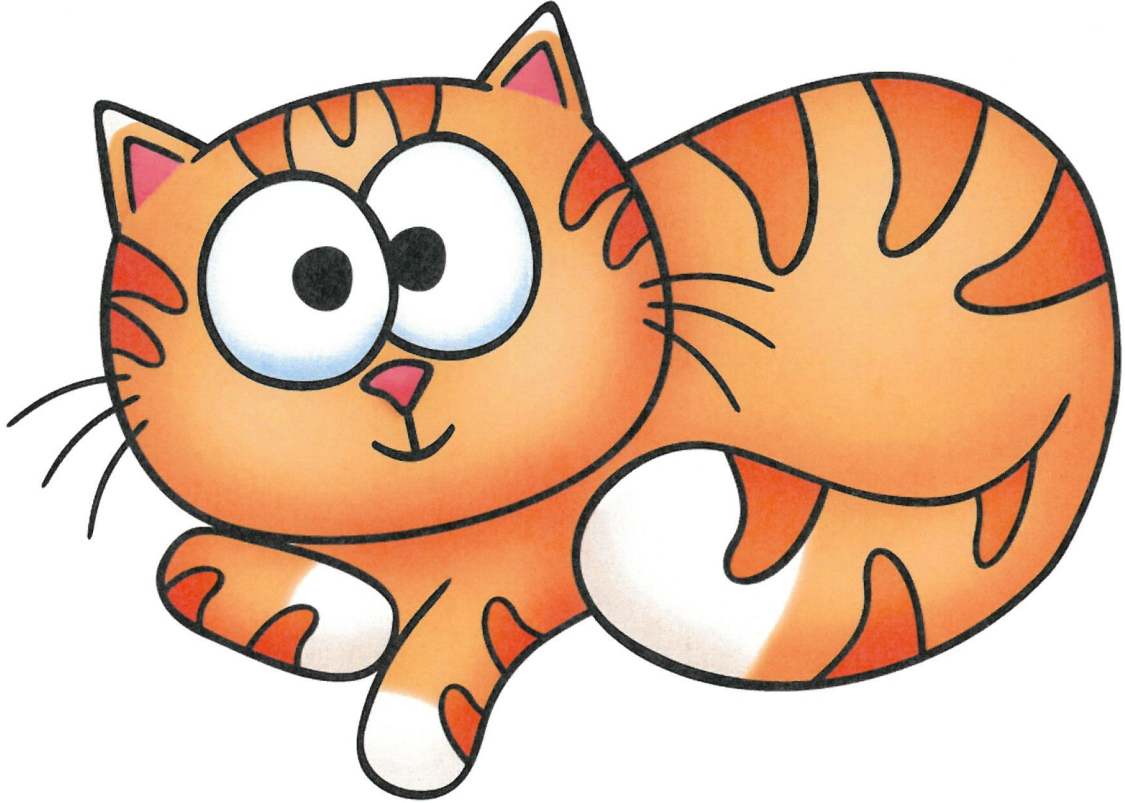

Cc

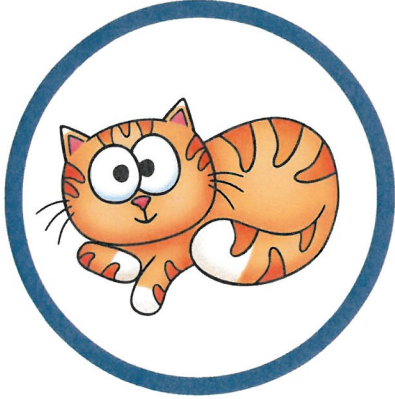

c a r



c a t

c a p

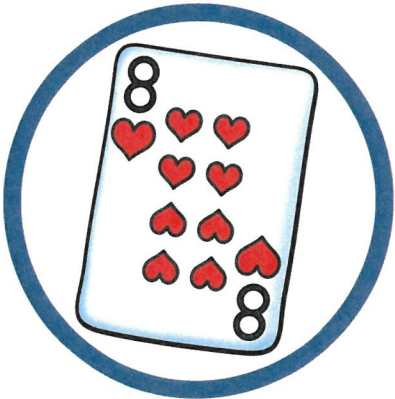

c o p



c a k e

c a r d



c a r t



c a m e l

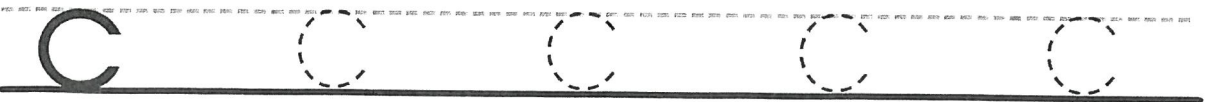
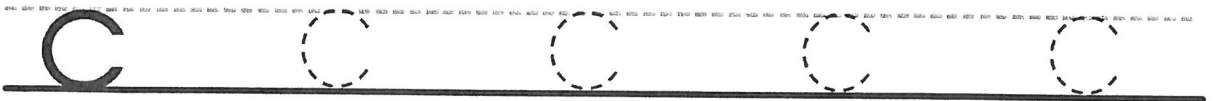
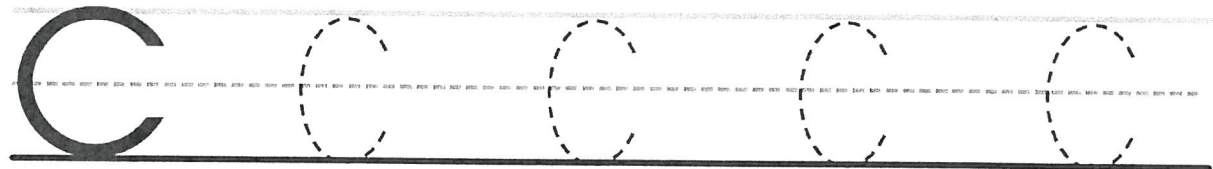
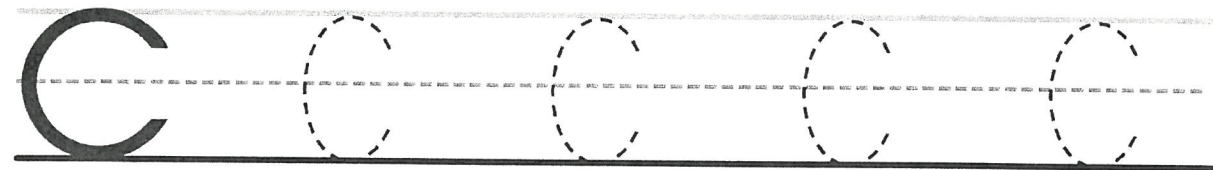
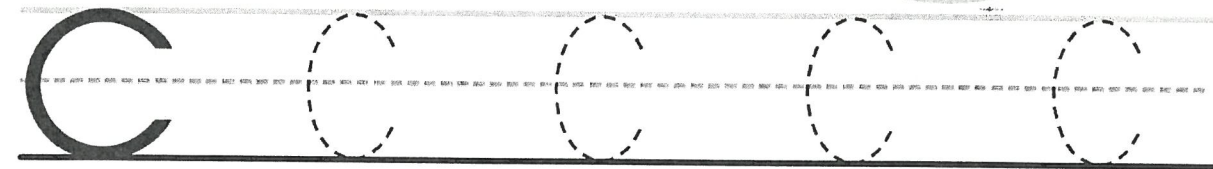
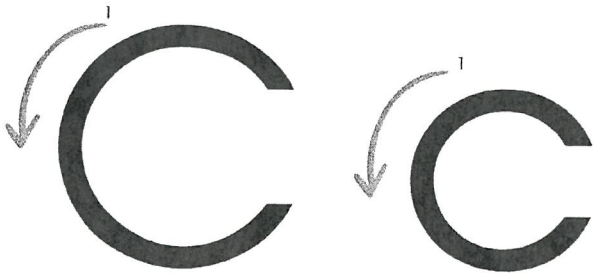

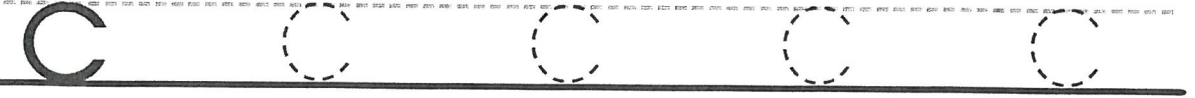
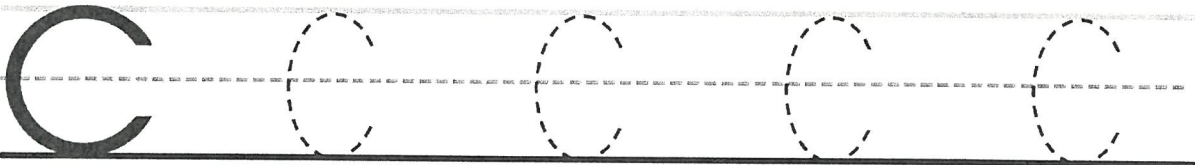
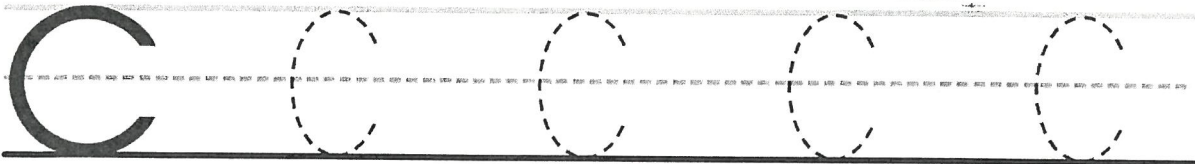
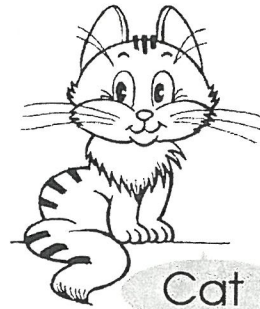
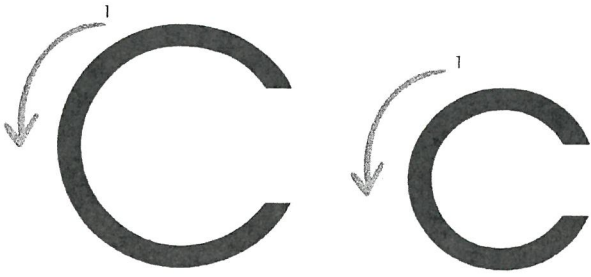

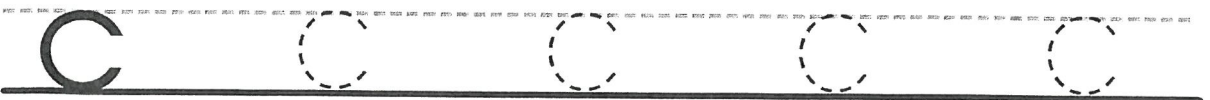
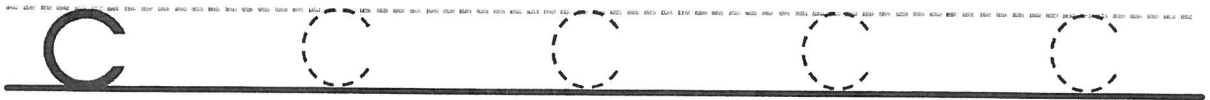
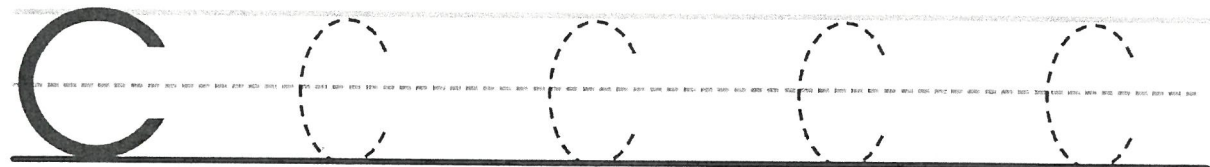
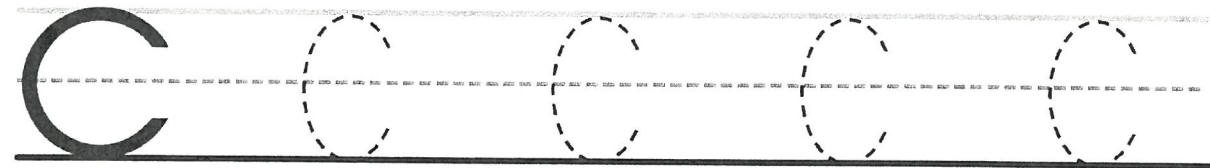
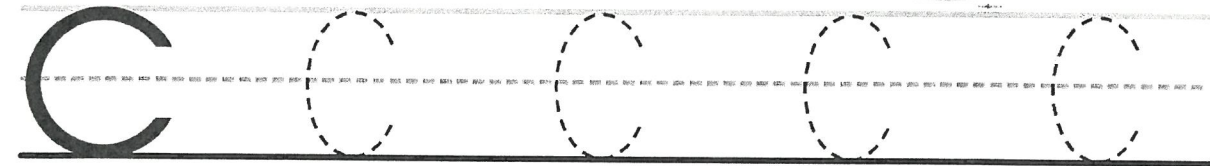
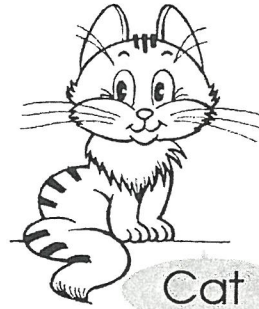
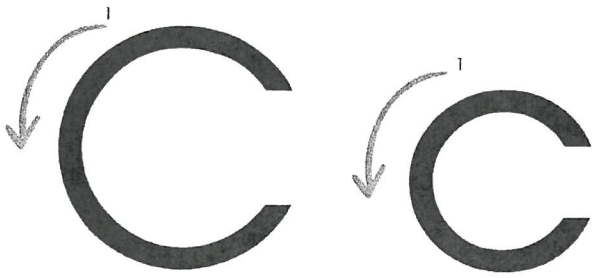

I name:

MATCH THE LETTER











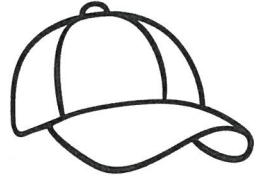

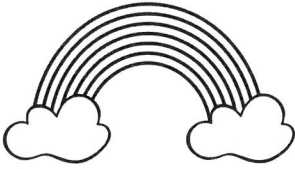
For each row circle the matching letter.

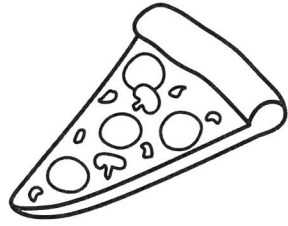
c	i	y	f	c
C	R	E	C	P
c	k	c	l	u
C	C	B	O	W
c	x	t	n	c
C	C	H	A	F

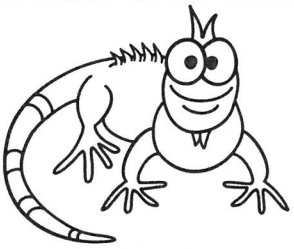
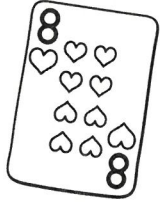
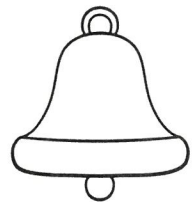
I name:

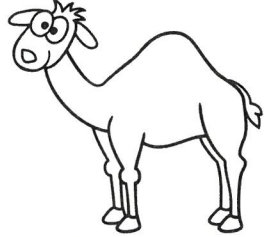
MATCH THE SOUND

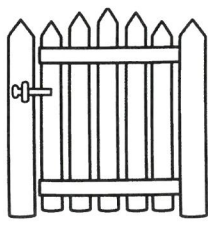
For each row color the picture to match the beginning sound.

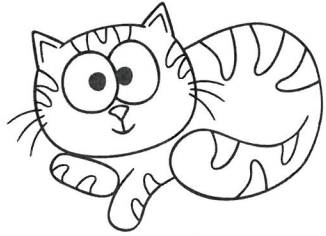
C			
C			
C			
C			
C			
C			

I name:

BUILD LETTER Cc WORDS

Cut and paste the letter c to complete each word.

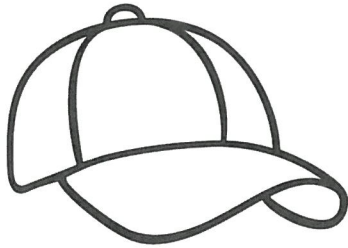

ap

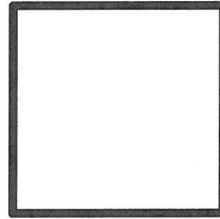

ake

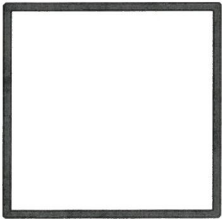

op

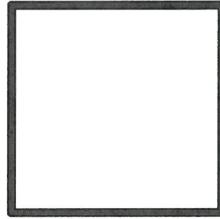
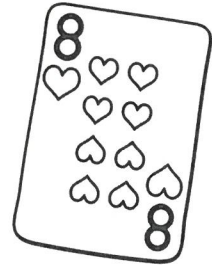

ard

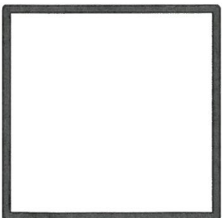
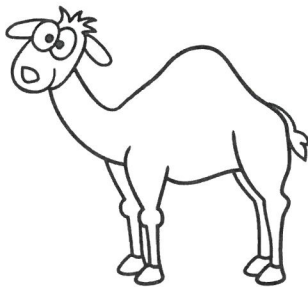

amel

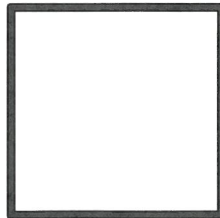
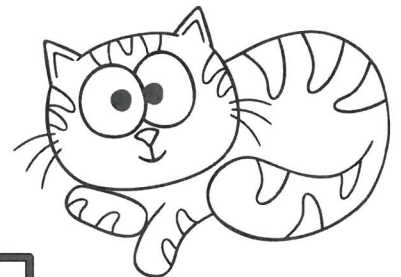

at

Name _____

Let's warm up!

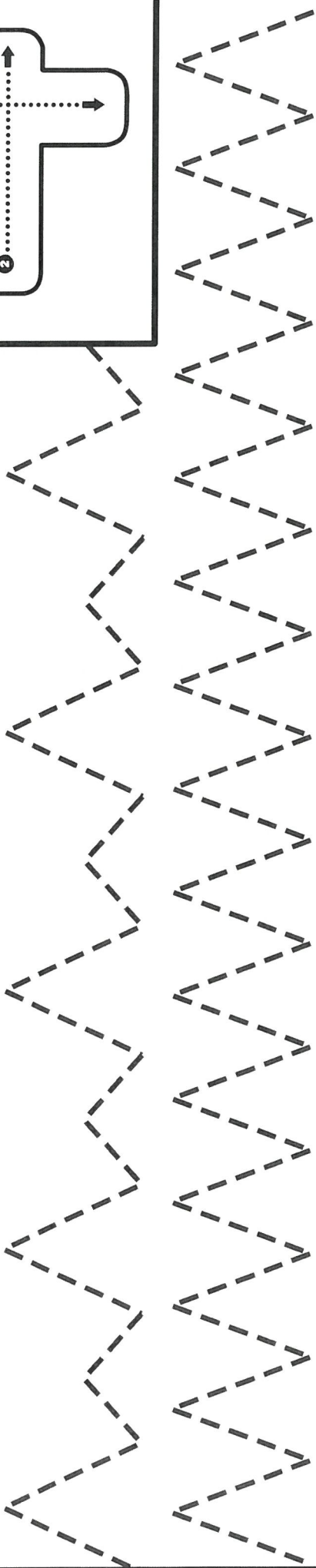

Let's trace the number!

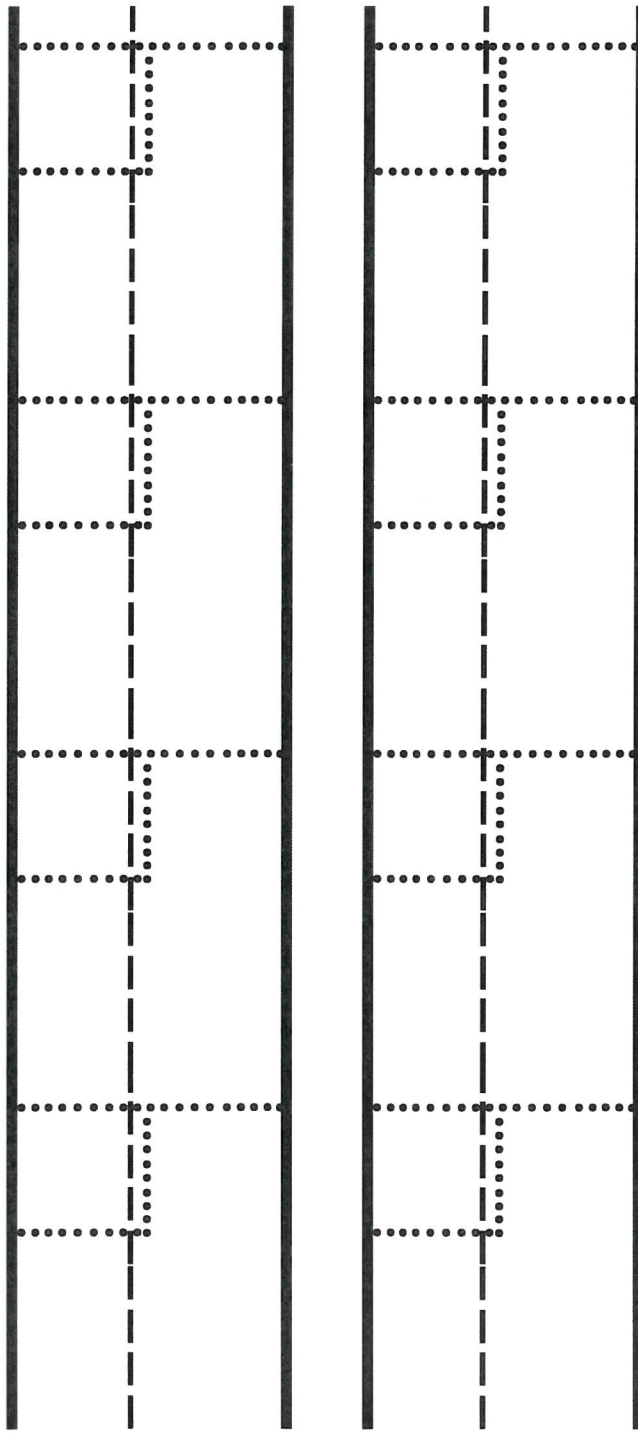

Let's Draw!



**four
legs**

Name _____

Let's warm up!

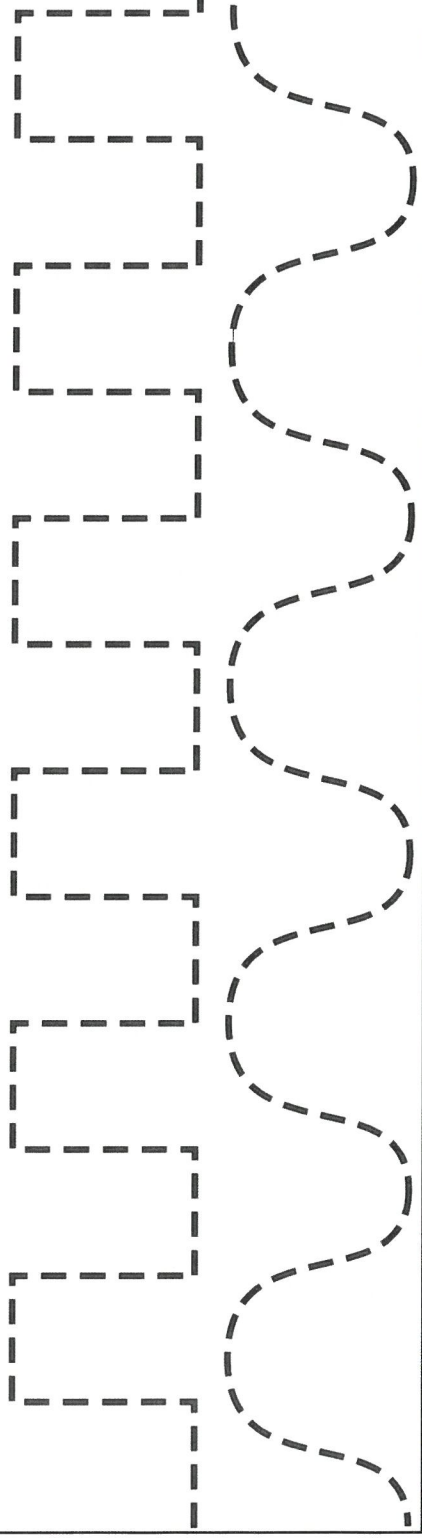

Let's trace the number!

Let's Draw!

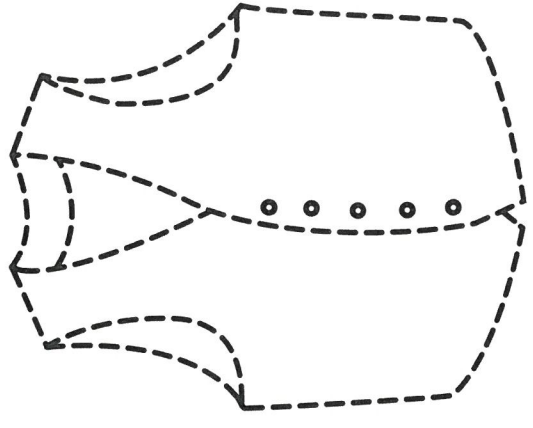
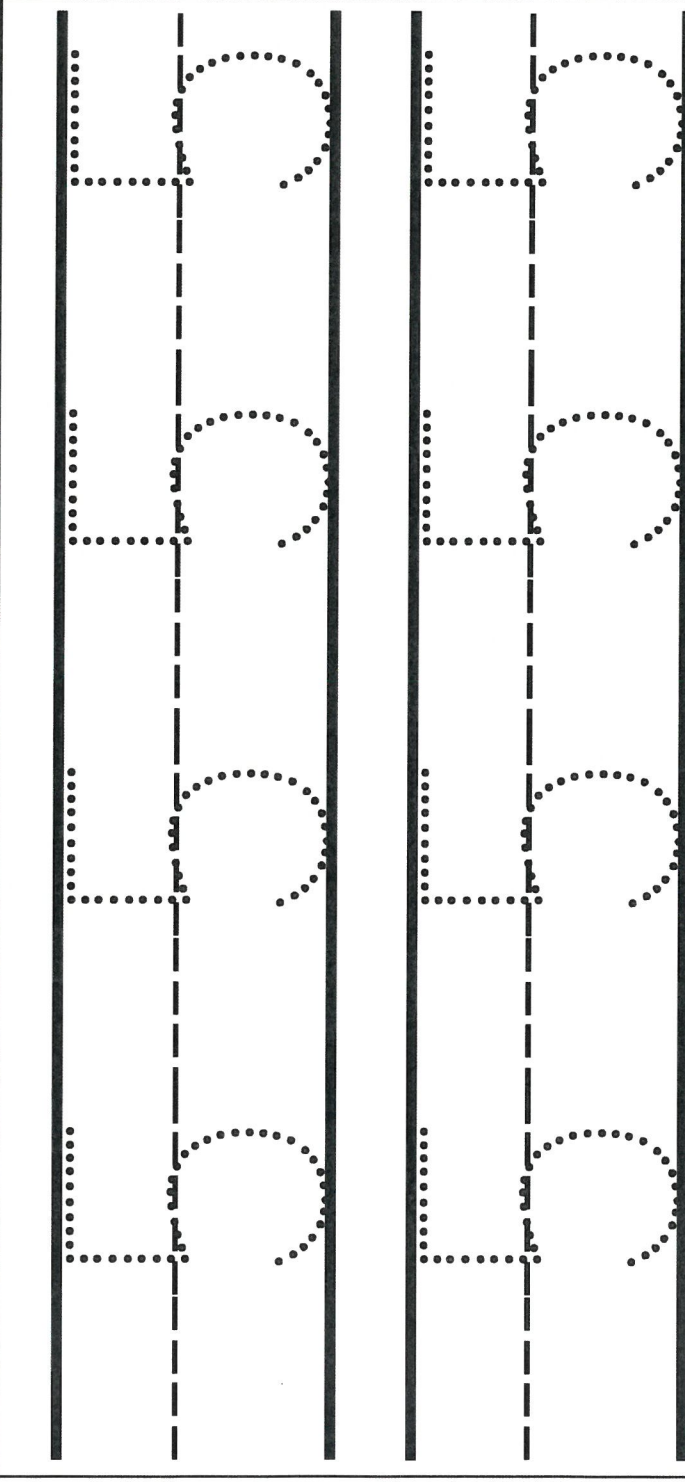
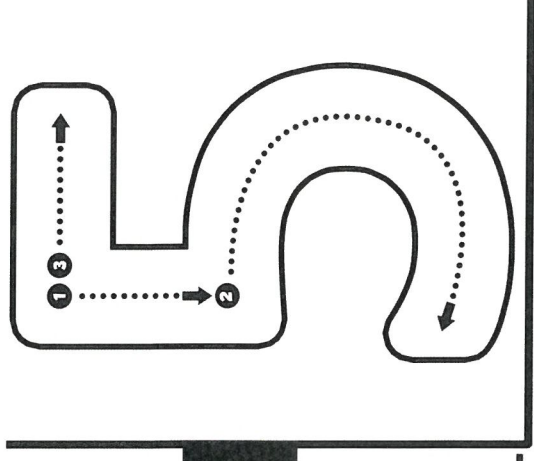

five buttons

Find the word that rhymes!

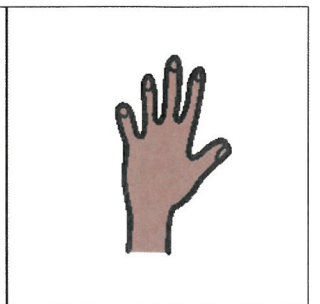
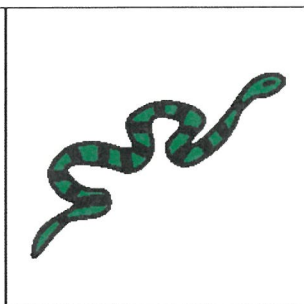
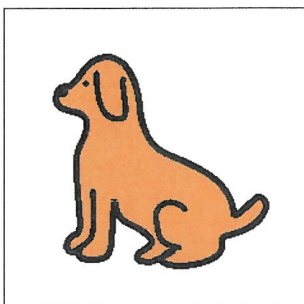
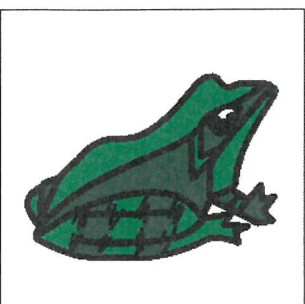
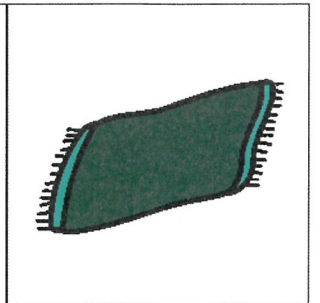
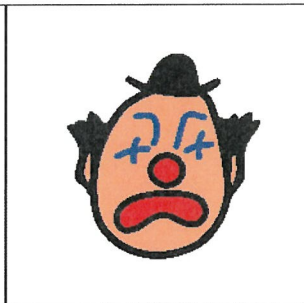
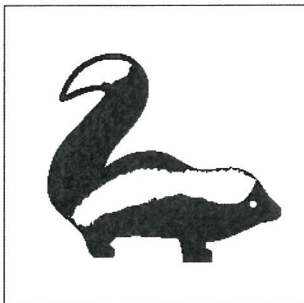
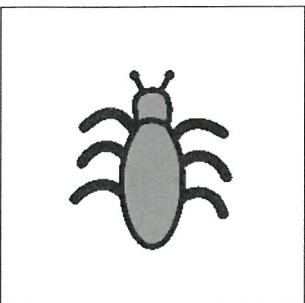
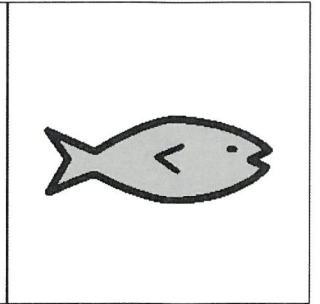
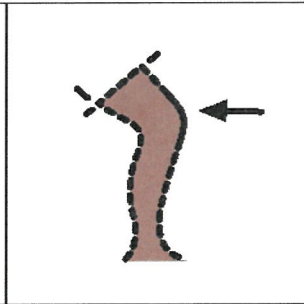
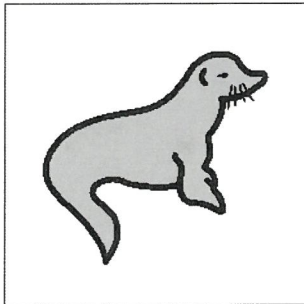
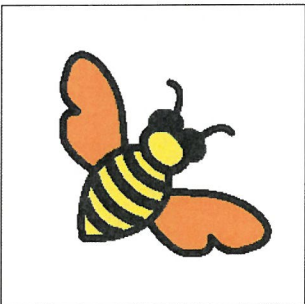
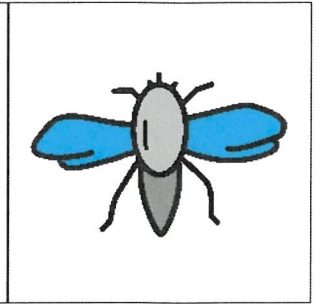
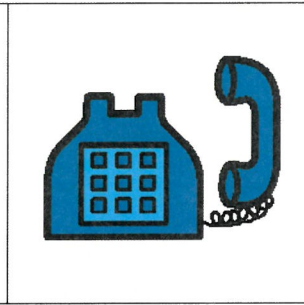
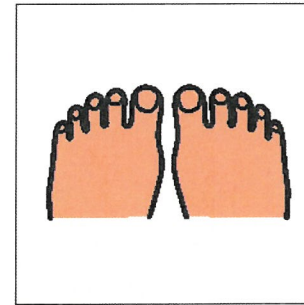
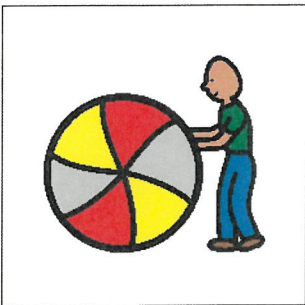
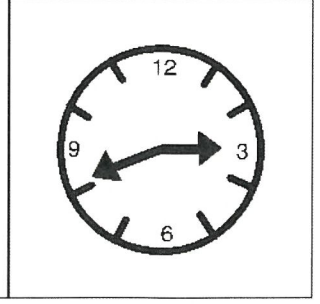
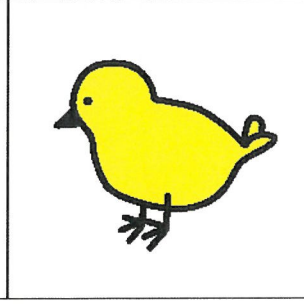
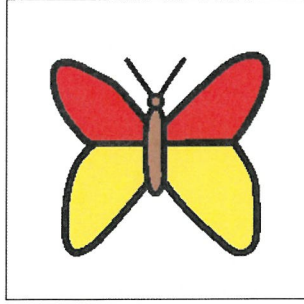
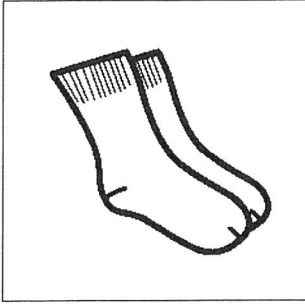

Week Three:

Dd

6,7



Dd

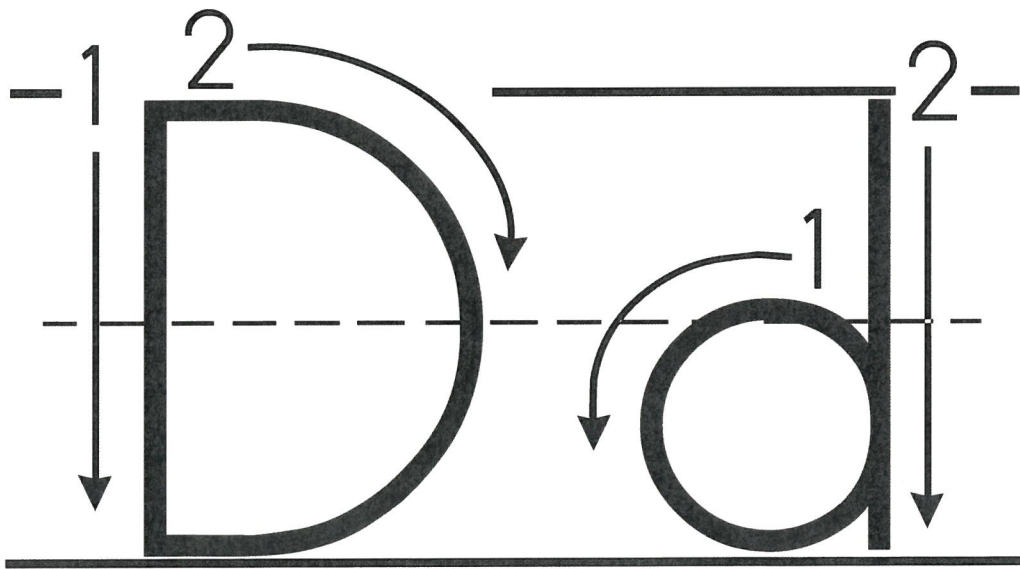

Dd

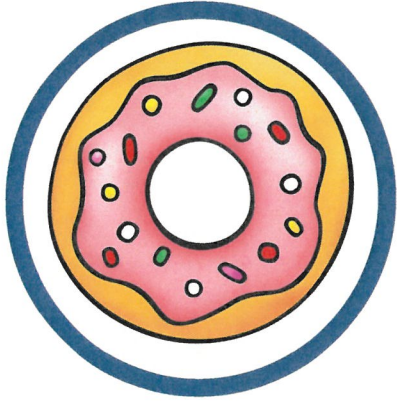

d o g

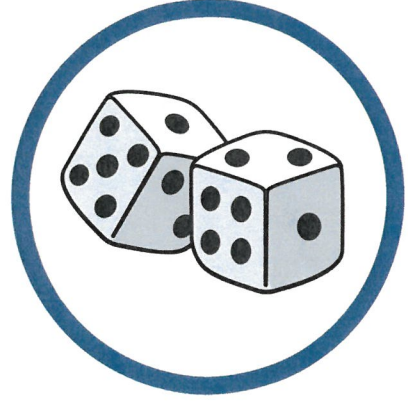

d o t

d o l l



d i c e



d r u m

d u c k



d o n u t



d o n k e y

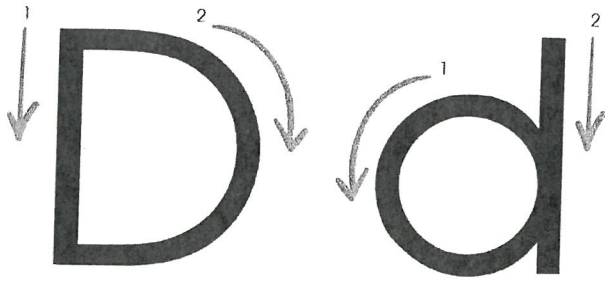

Dog

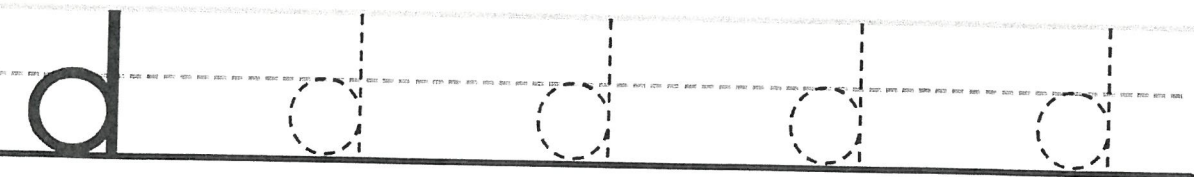
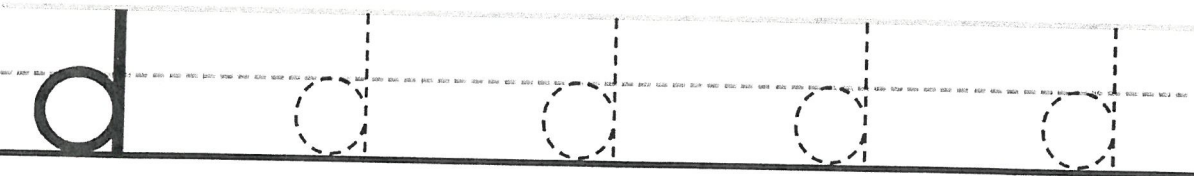
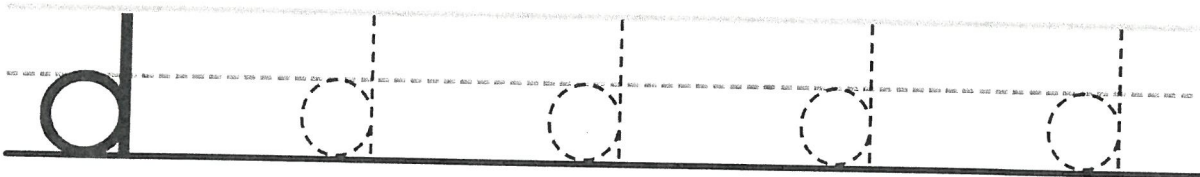
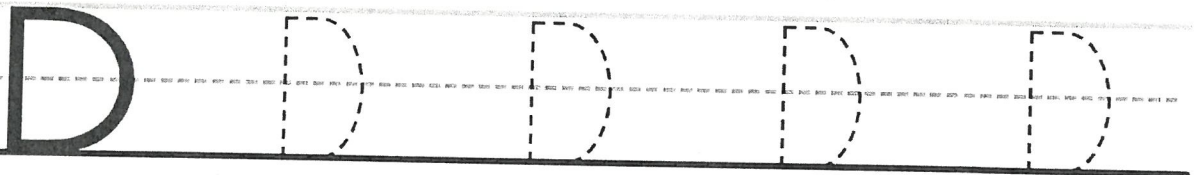
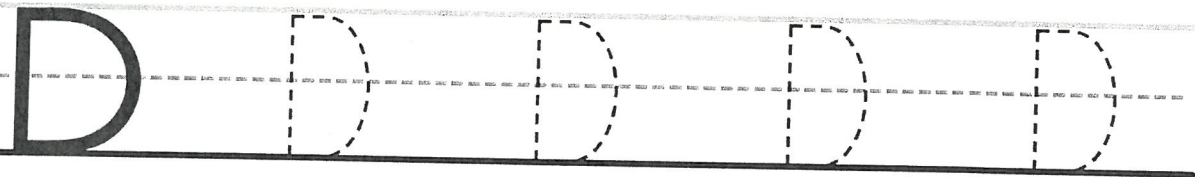
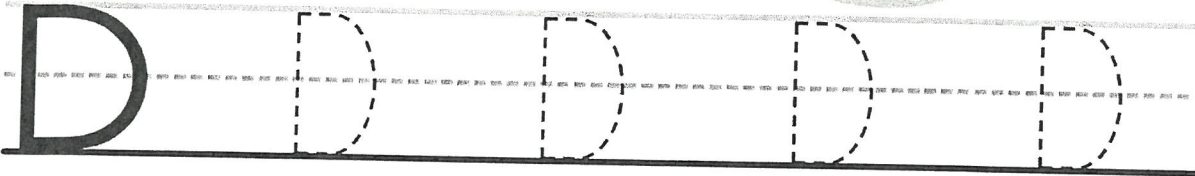

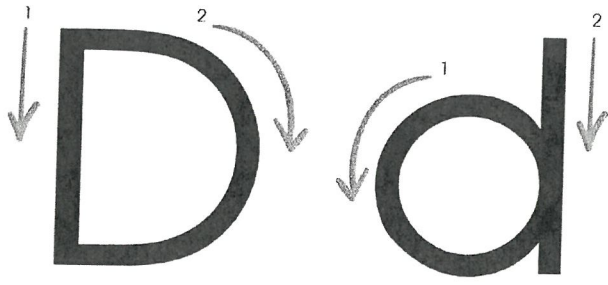

Dog

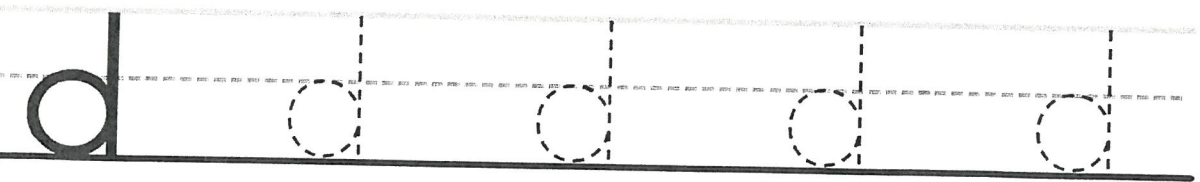
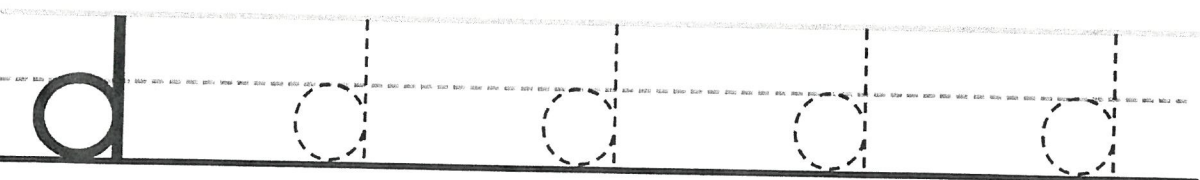
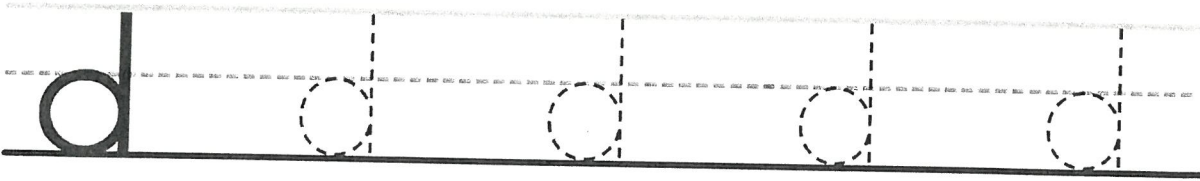
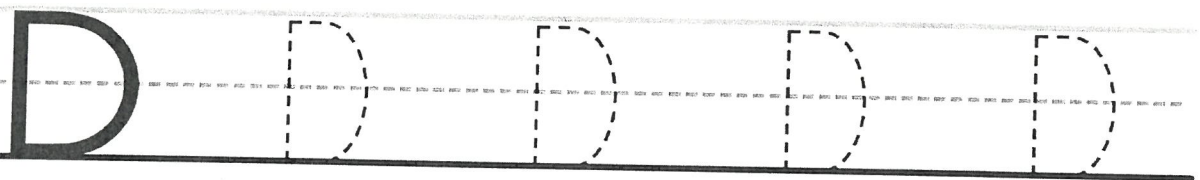
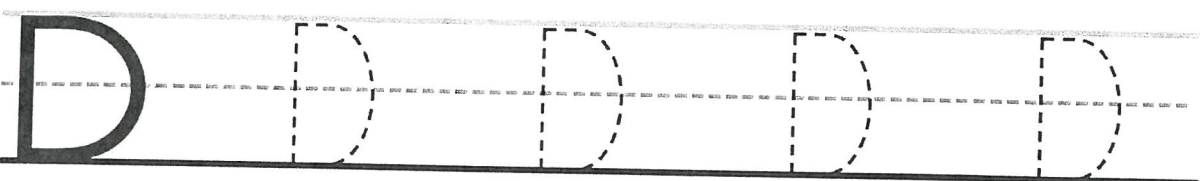
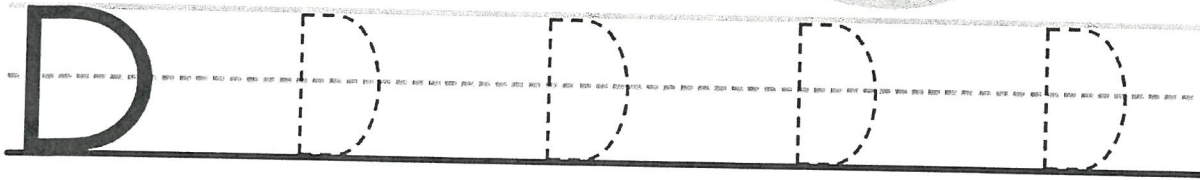

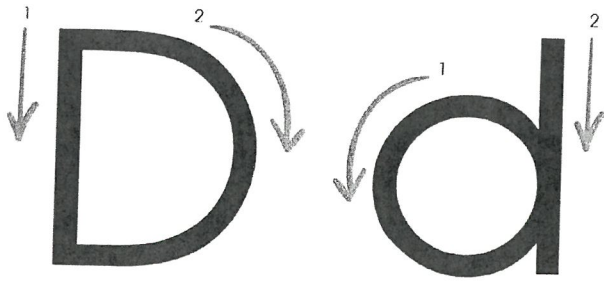

Dog

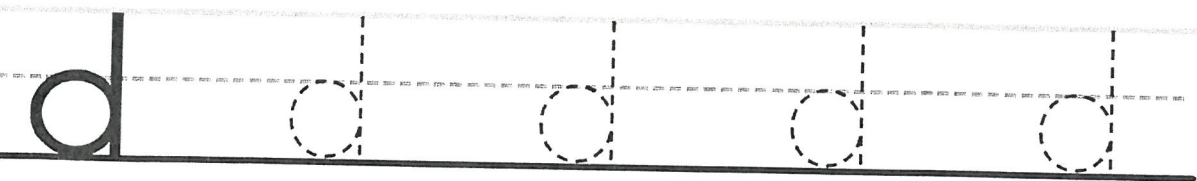
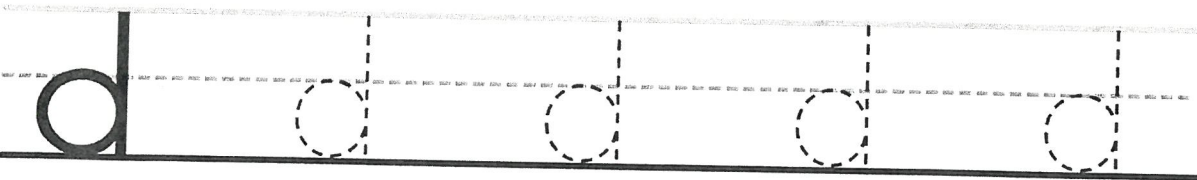
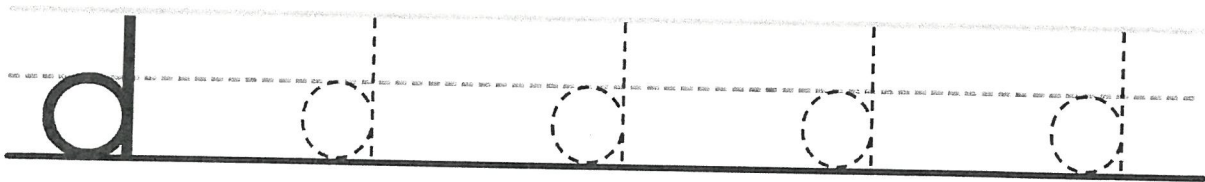
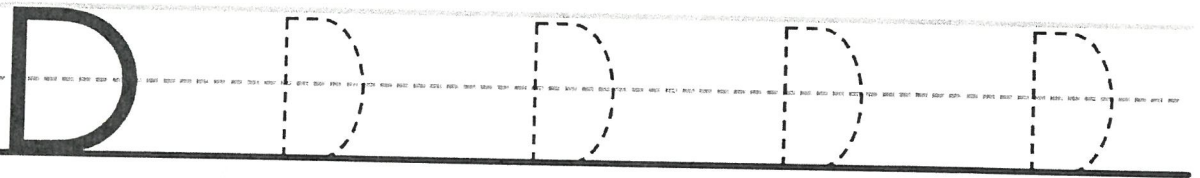
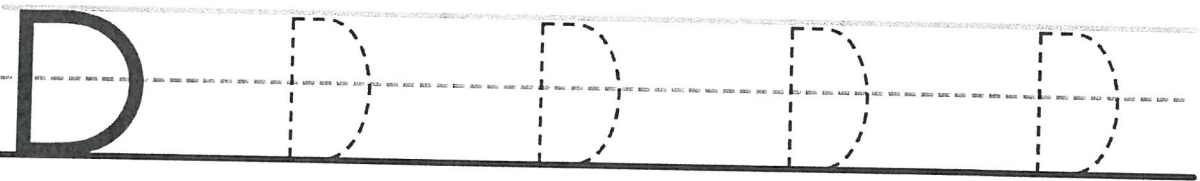
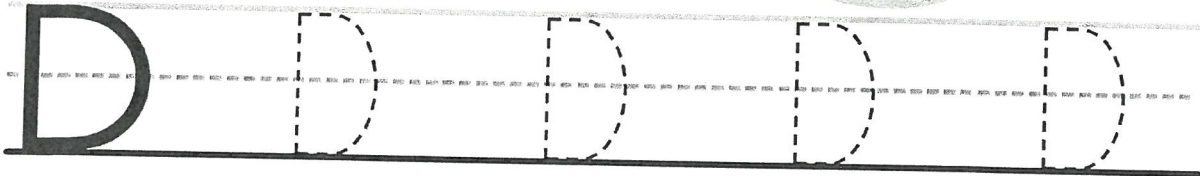

I name:

MATCH THE LETTER











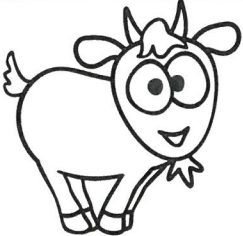

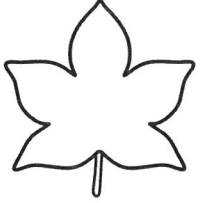
For each row circle the matching letter.

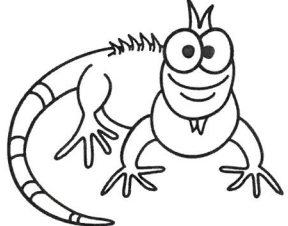
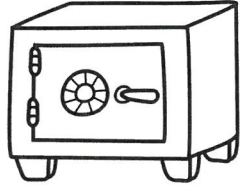
d	h	a	m	d
D	S	D	R	E
d	d	u	i	o
D	N	A	D	F
d	v	d	x	l
D	Y	G	B	D

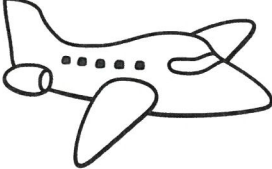
I name:

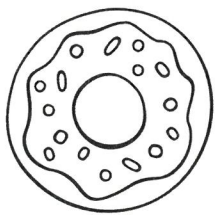
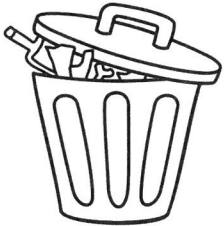
MATCH THE SOUND

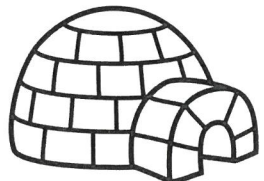
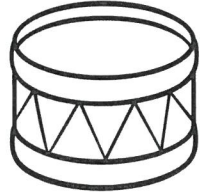
For each row color the picture to match the beginning sound.

d			
d			
d			
d			
d			
d			

I name:

BUILD LETTER Dd WORDS

Cut and paste the letter d to complete each word.



uck

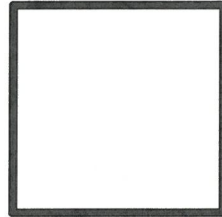
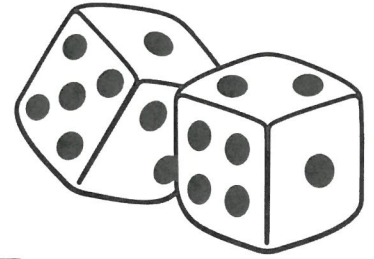

ice

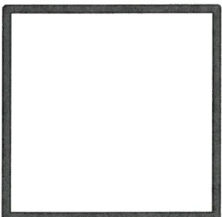
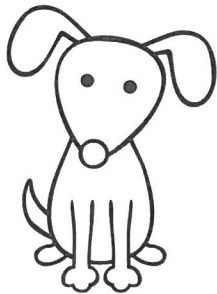

og

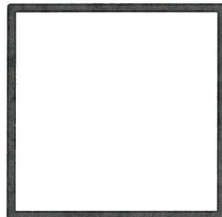

oll

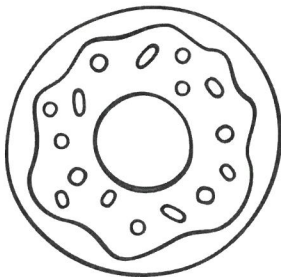

onut

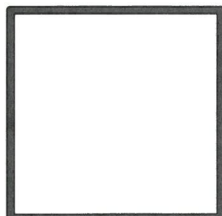
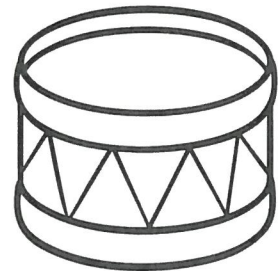

rum

Name _____

Let's warm up!

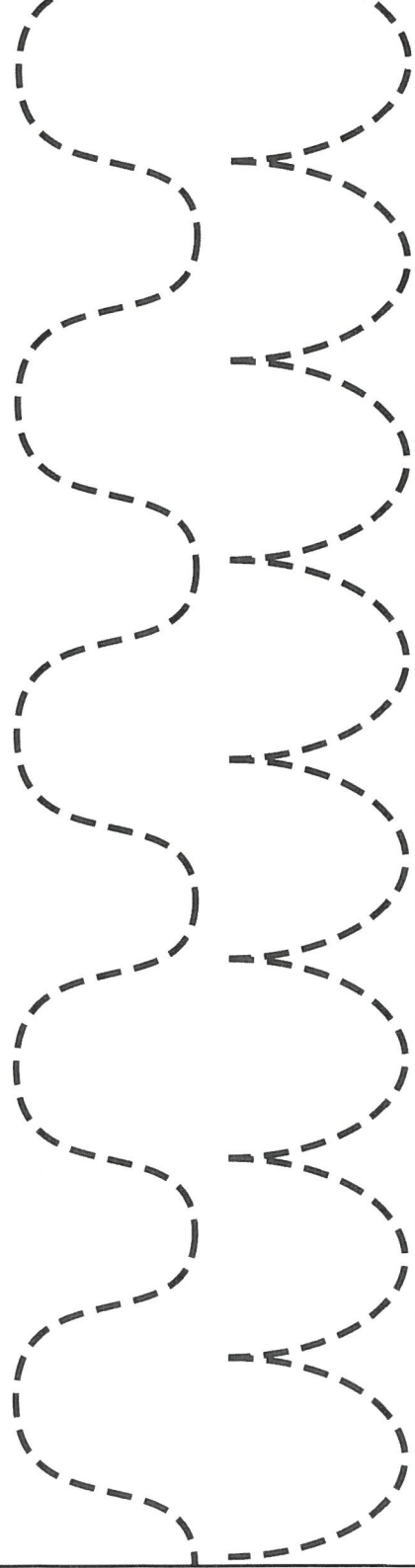

Let's trace the number!

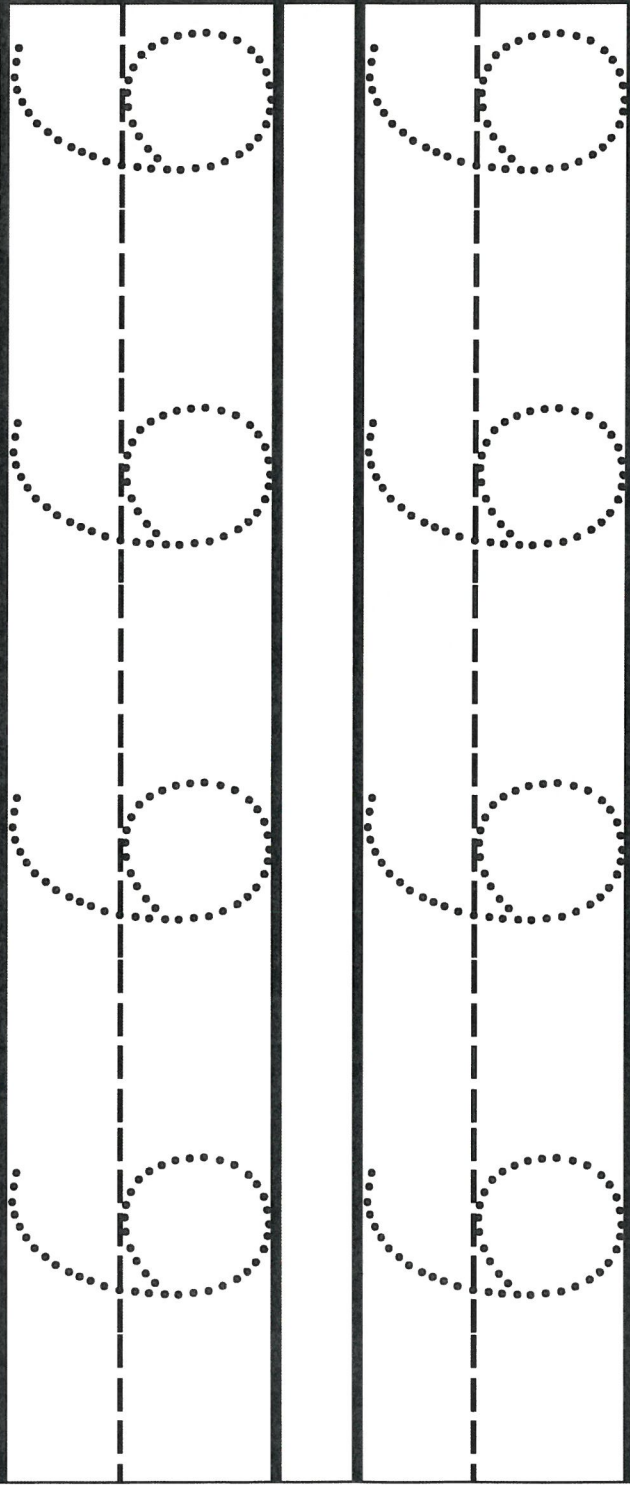

Let's Draw!



six legs

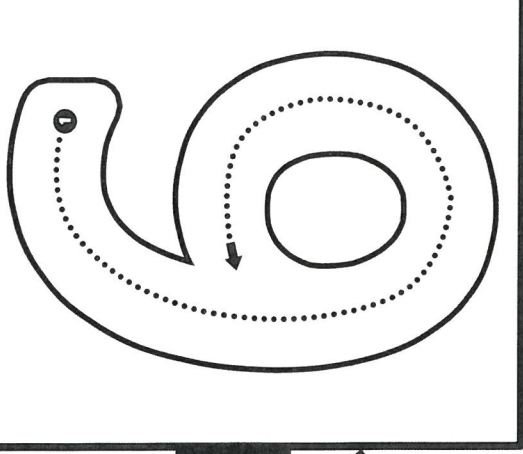

Name _____

Let's warm up!

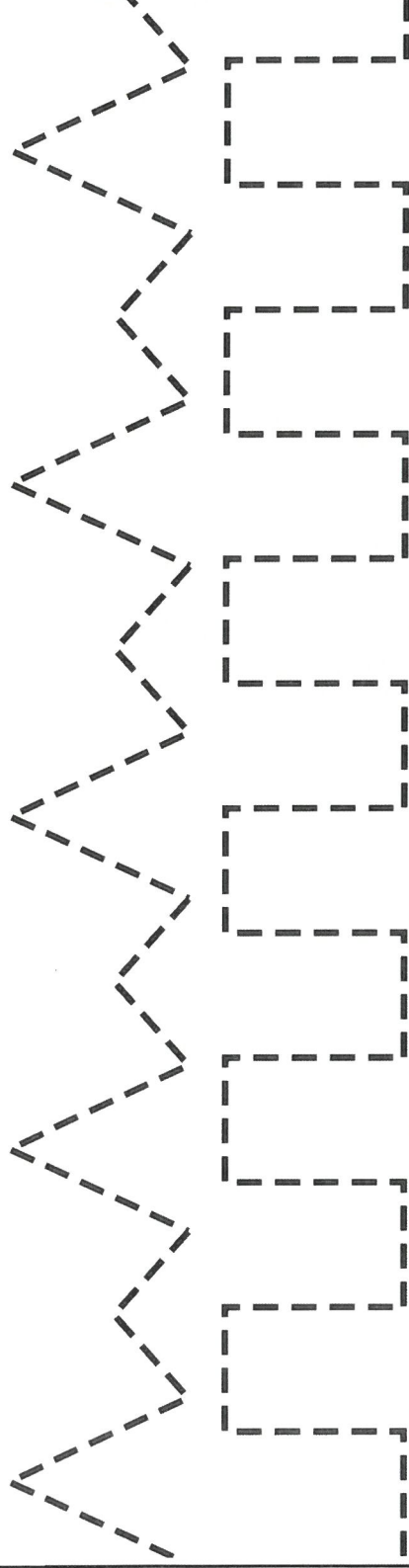

Let's trace the number!

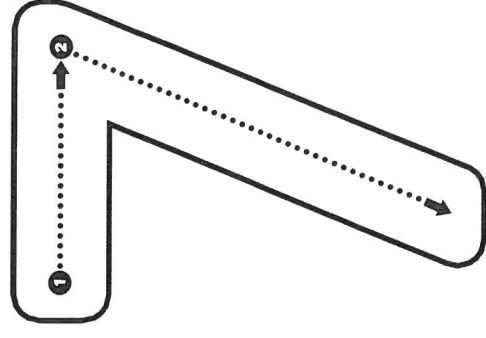
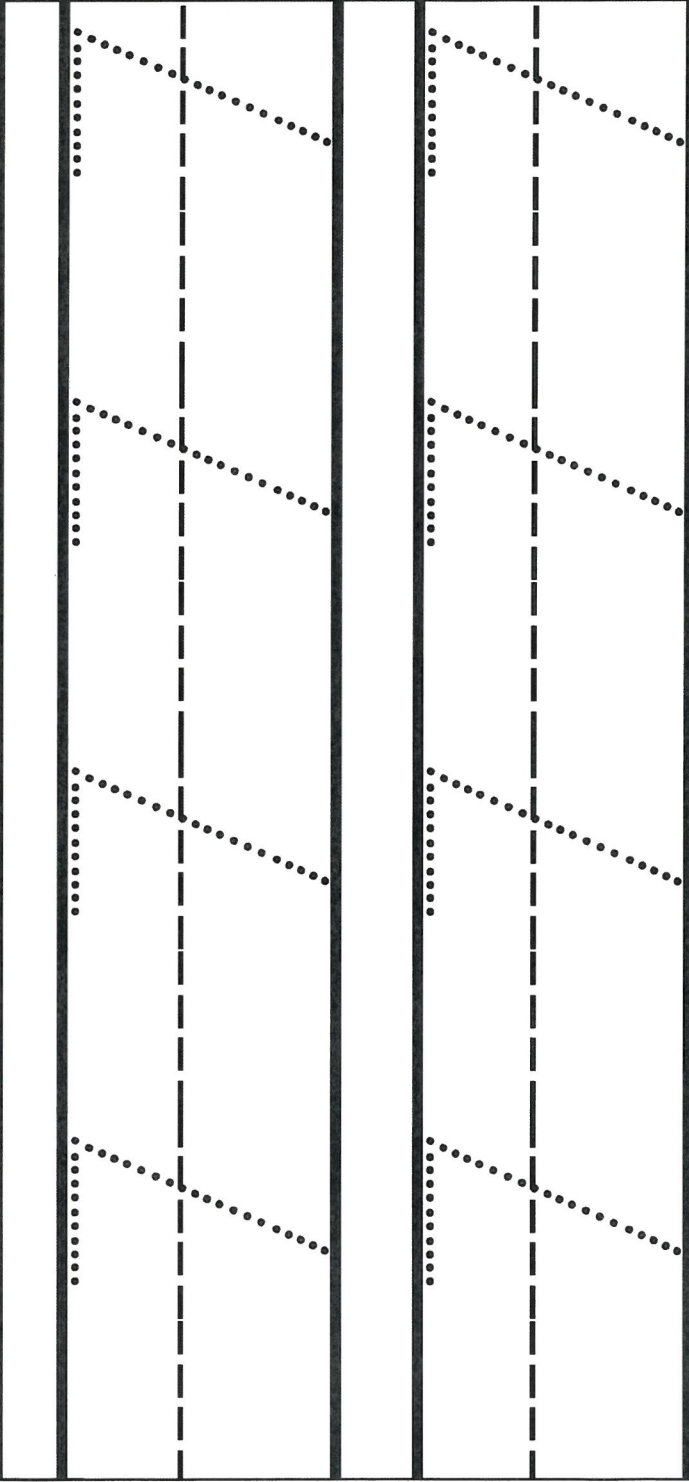

Let's Draw!

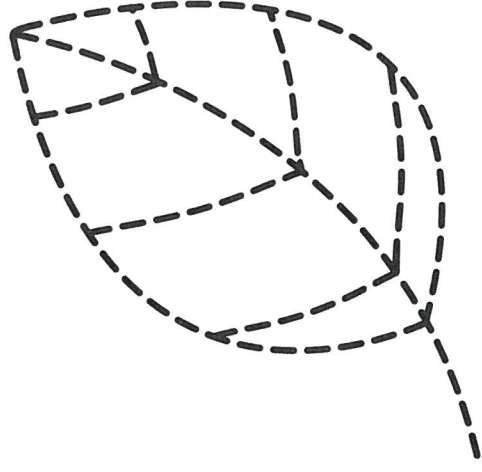

seven lines

Find the word that rhymes!

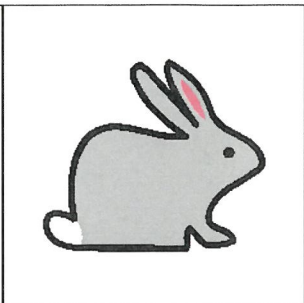
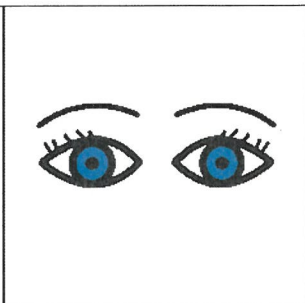
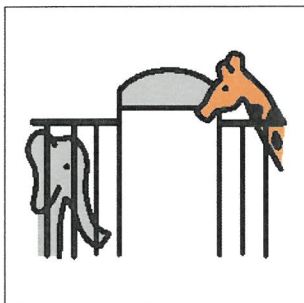
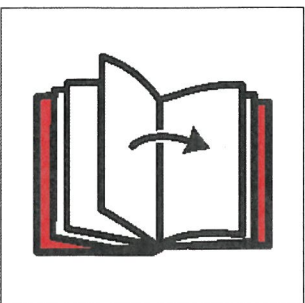
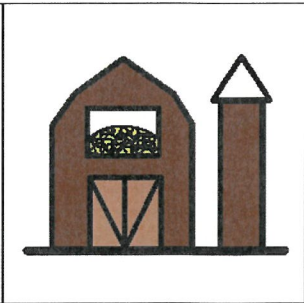
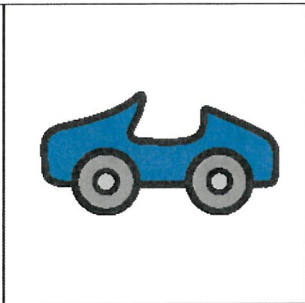
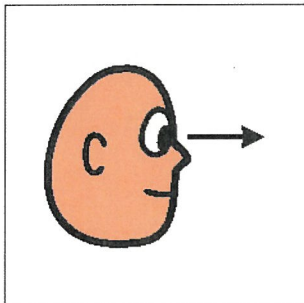
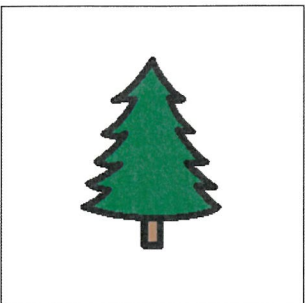
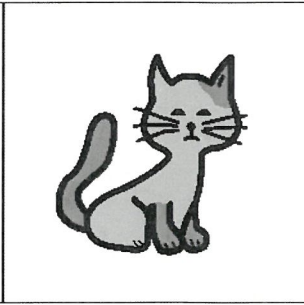
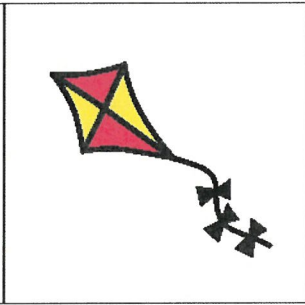
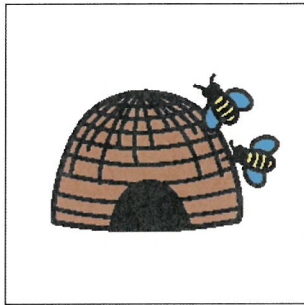
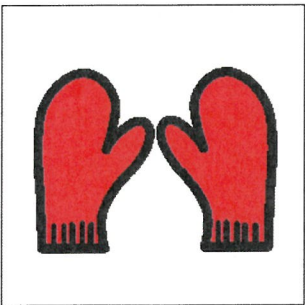
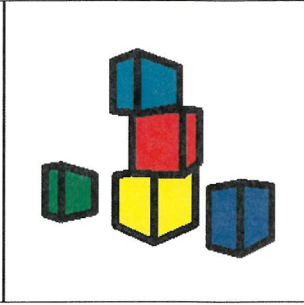
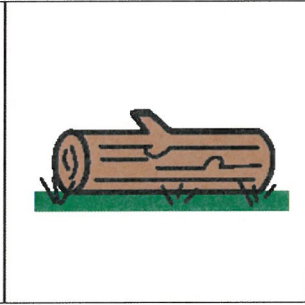
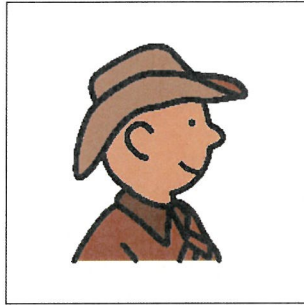
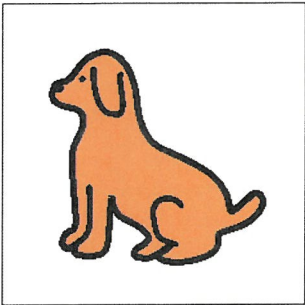
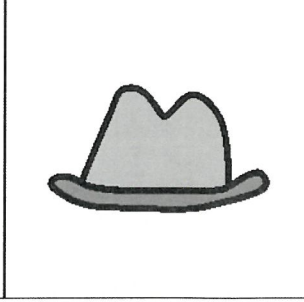
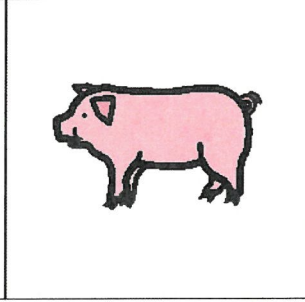
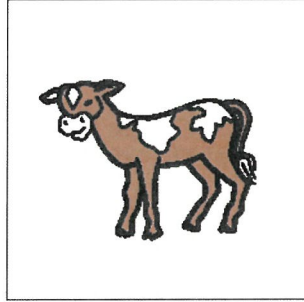
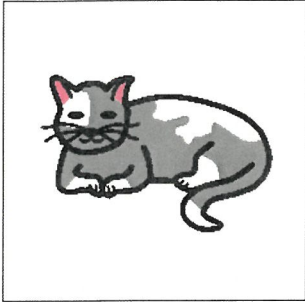

Week Four:

Ee & Ff

8, 9, 10

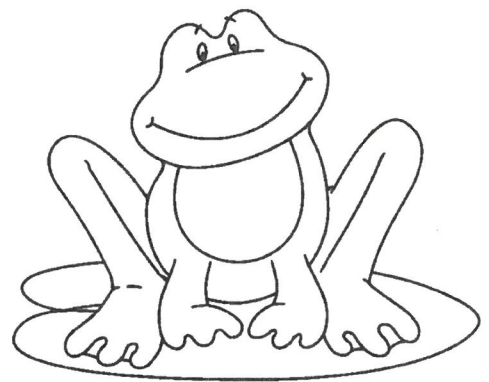
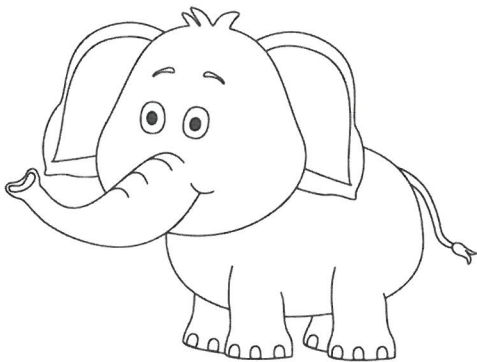

Ee

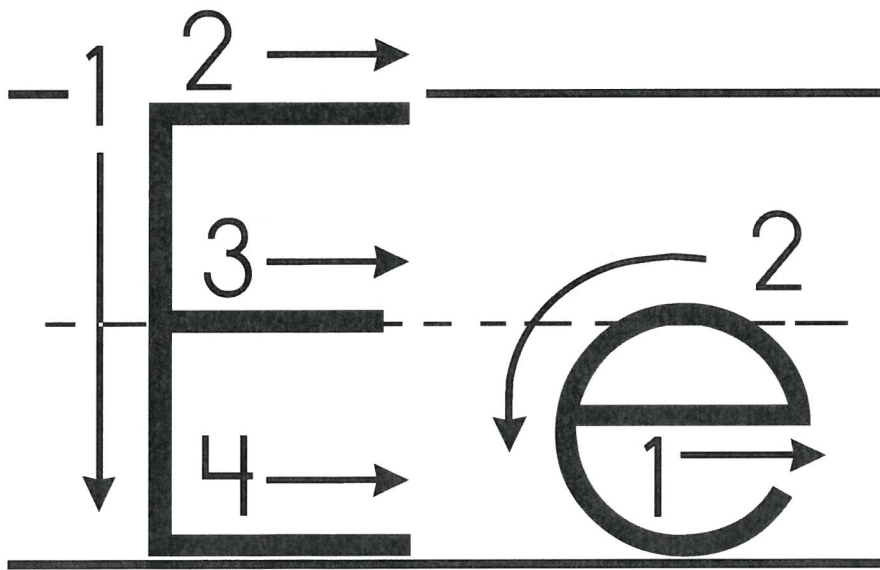

Ee



e

a r

e

e l

e

g g

e

l f

e

m u

e

a g l e

e

r a s e r

e

l e v e n

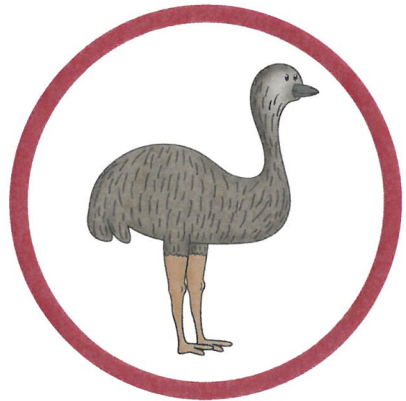
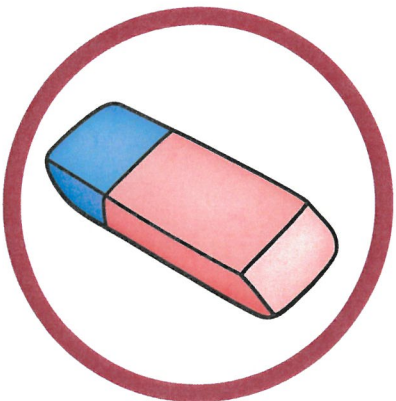
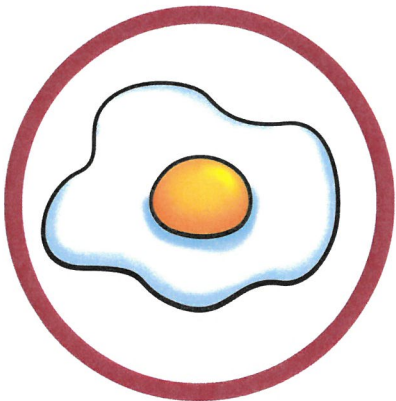

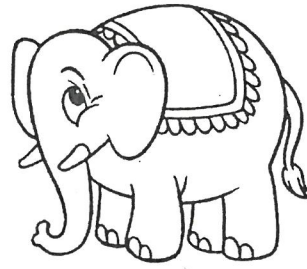
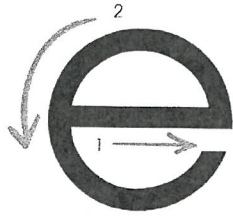
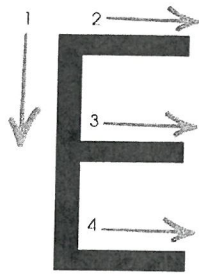

Elephant

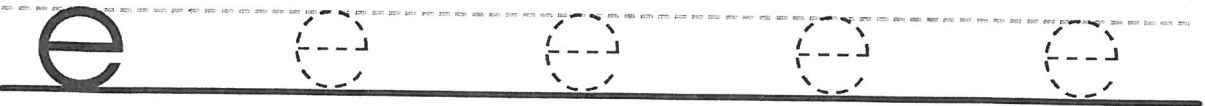
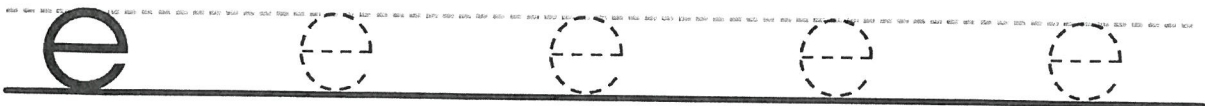
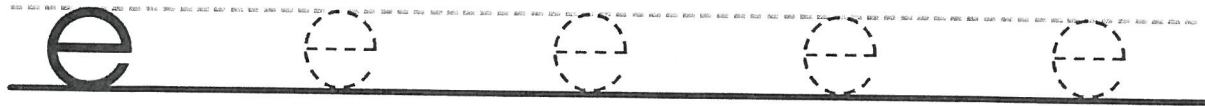
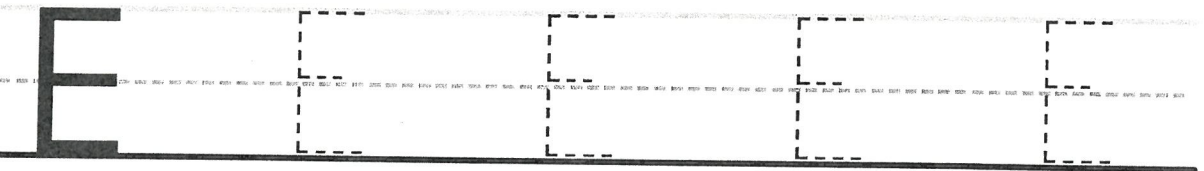
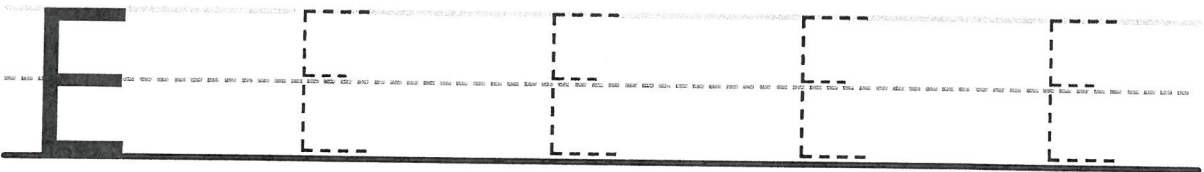
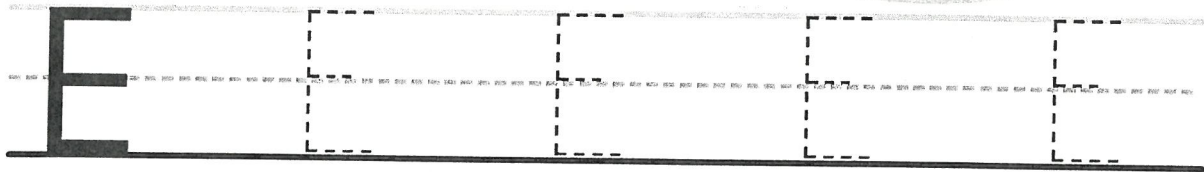

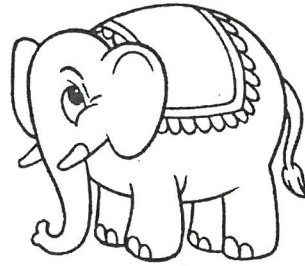
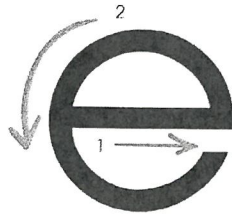
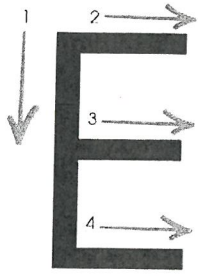

Elephant

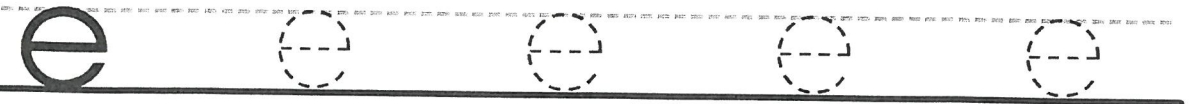
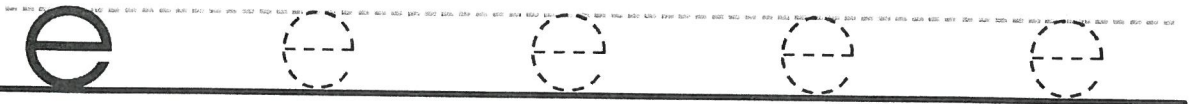
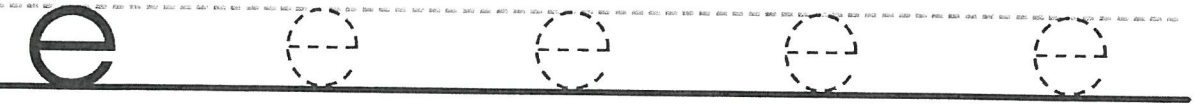
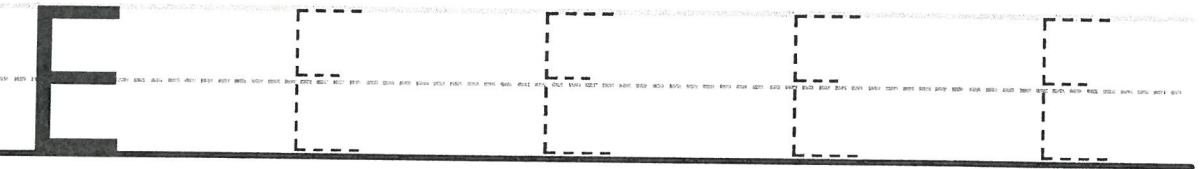
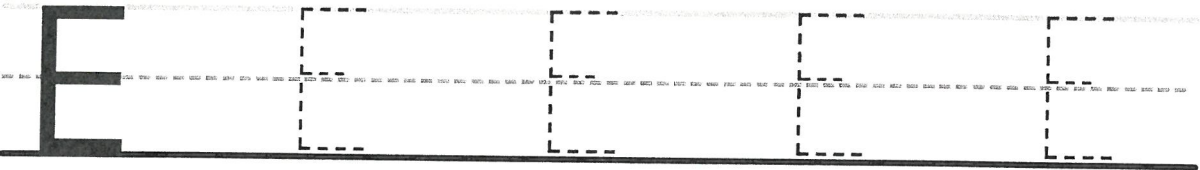
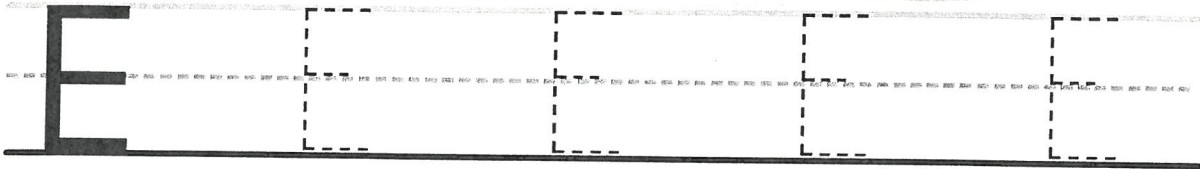

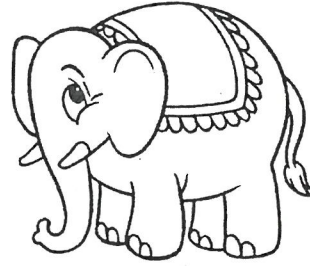
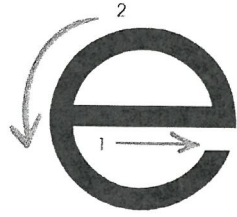
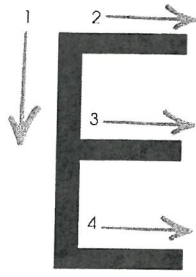

Elephant

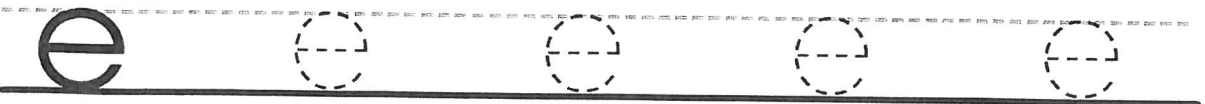
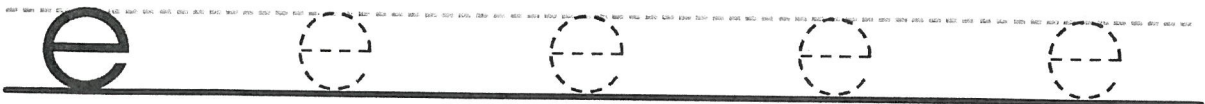
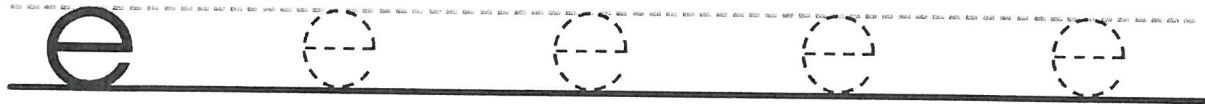
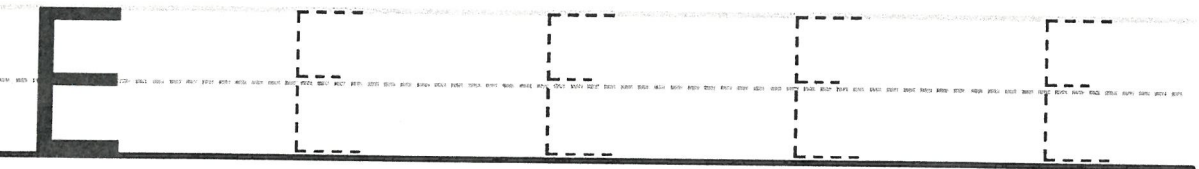
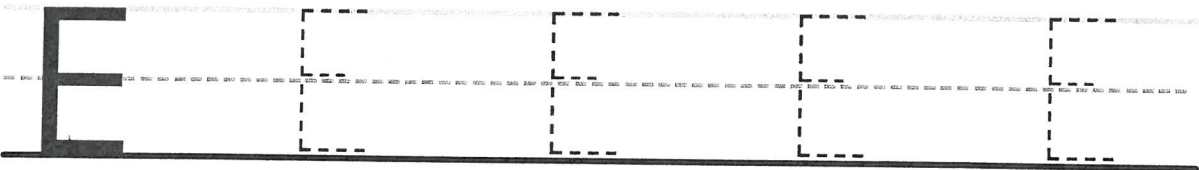
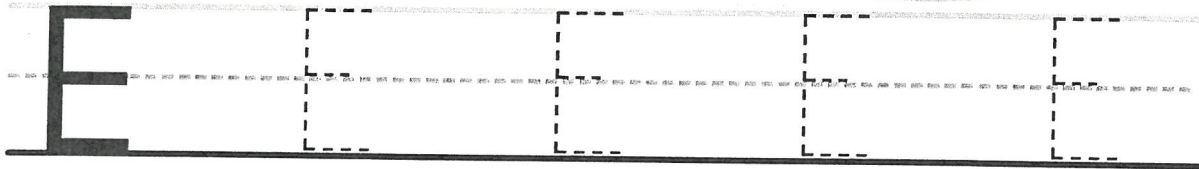

Name: _____

MATCH THE LETTER









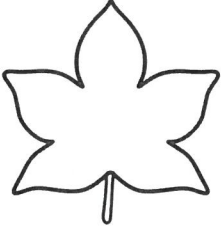
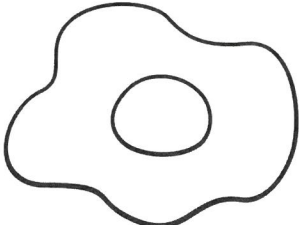
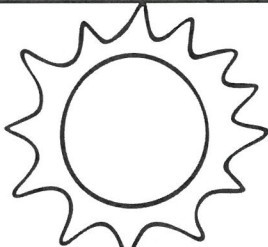
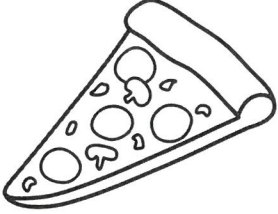
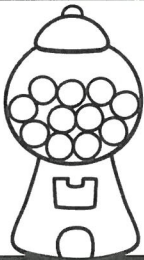
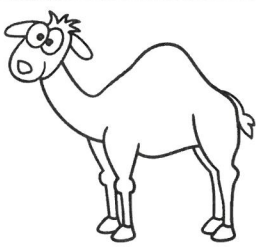
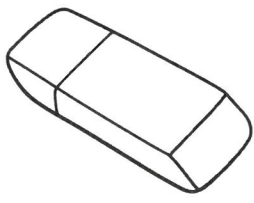

For each row circle the matching letter.

e	o	g	t	e
E	H	E	P	A
e	u	e	k	s
E	E	I	R	B
e	f	u	e	n
E	M	J	E	Q

I name:

MATCH THE SOUND

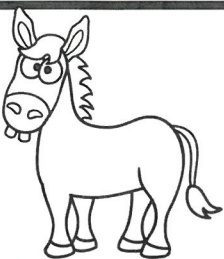
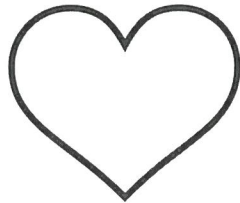
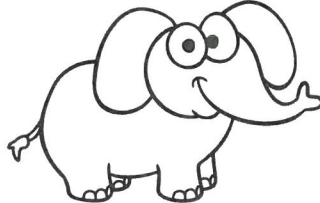
For each row color the picture to match the beginning sound.

e			
e			
e			
e			
e			
e			

I name:

BUILD LETTER Ee WORDS

Cut and paste the letter e to complete each word.

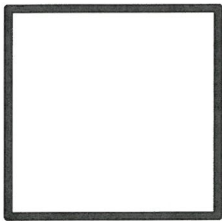

agle

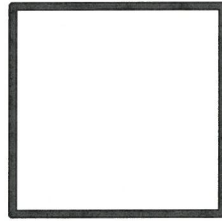
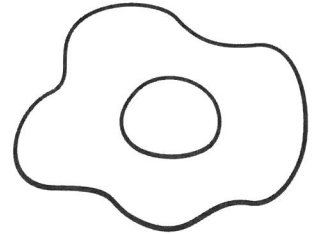

gg

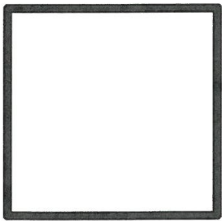
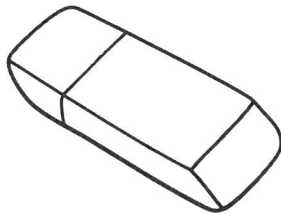

raser

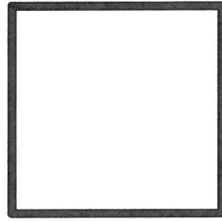
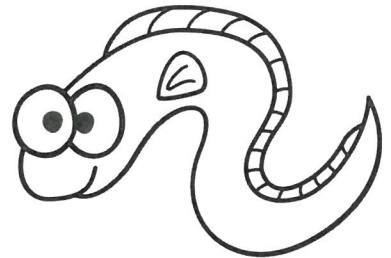

el

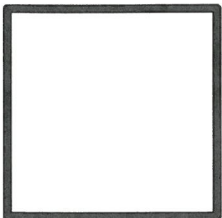
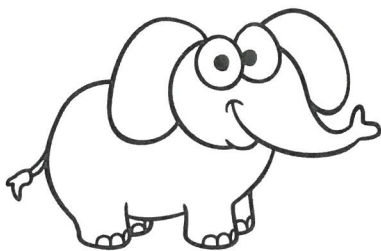

lephant

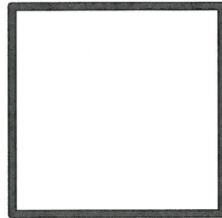

ar

Ff

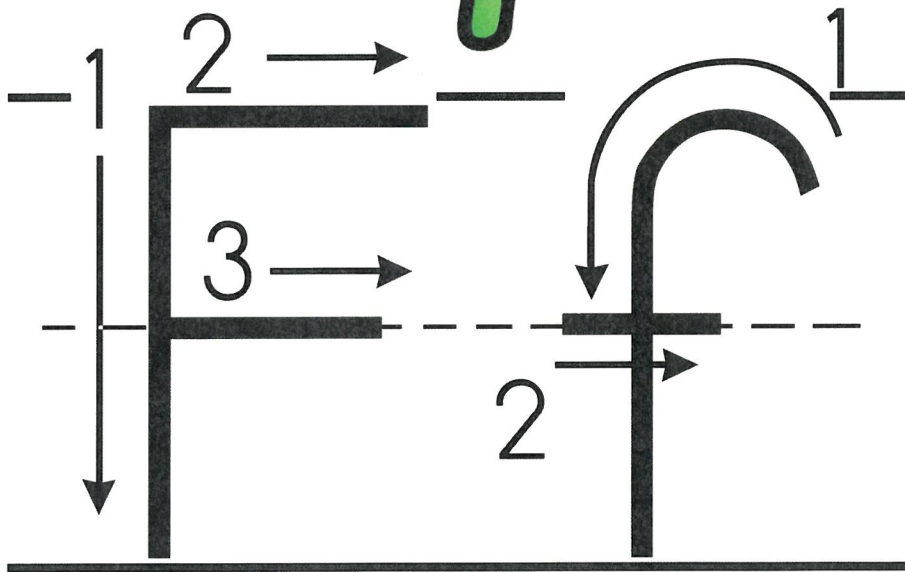

Ff

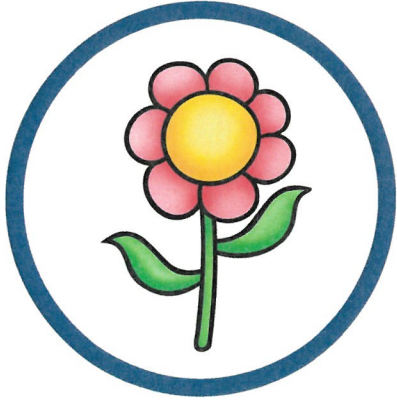

f

a t

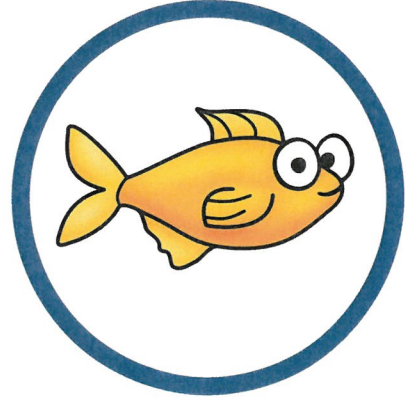

f

i t

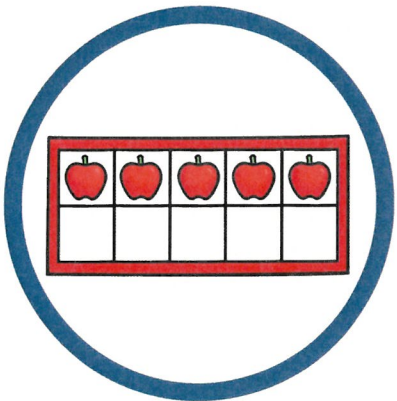

f

o x



f

i s h

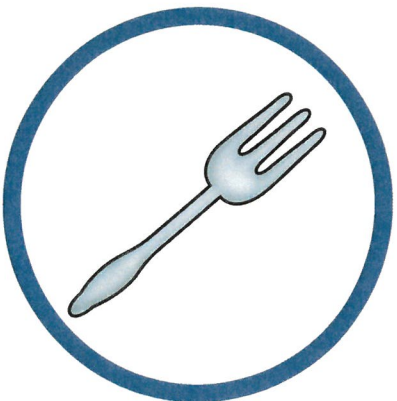

f

i v e



f

o o t

f

o r k

f

a i r y

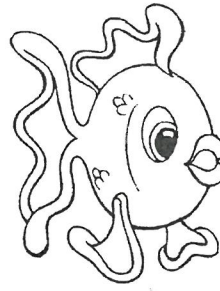
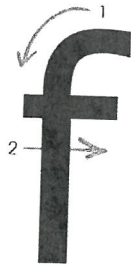
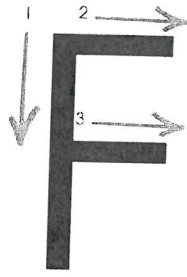

Fish

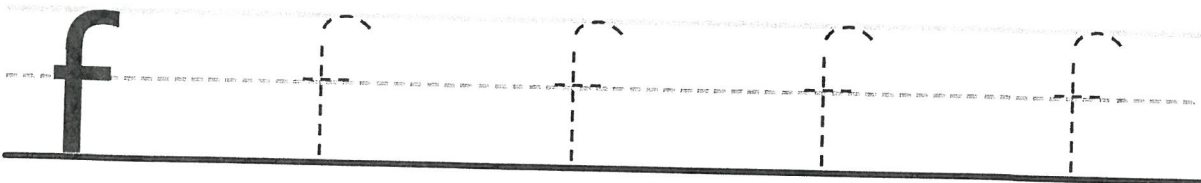
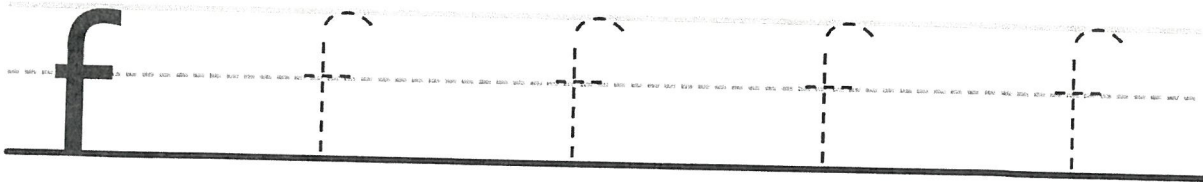
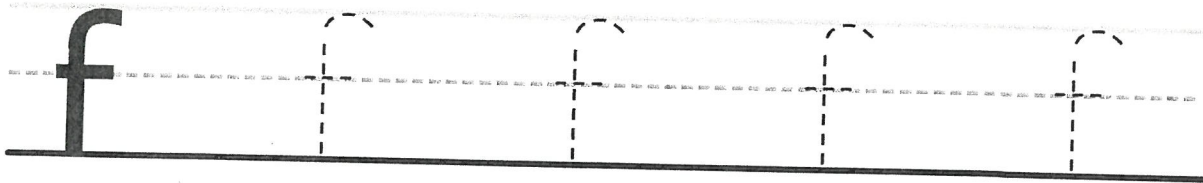
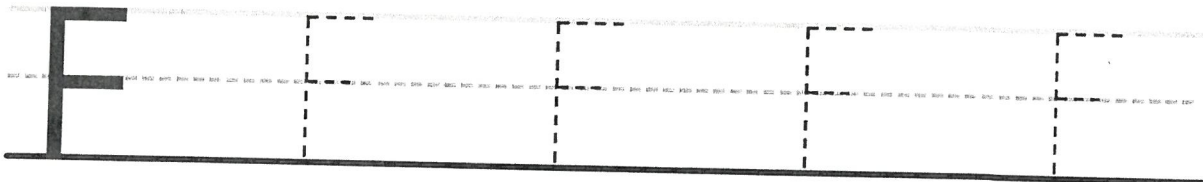
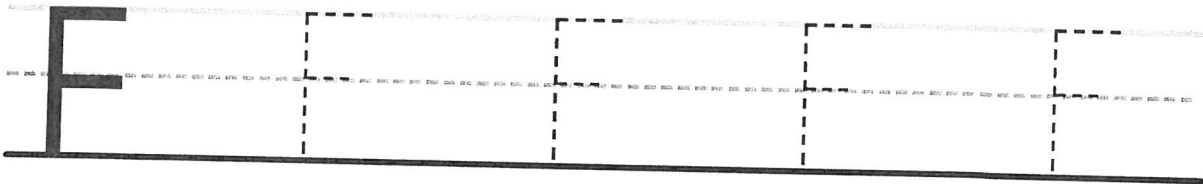
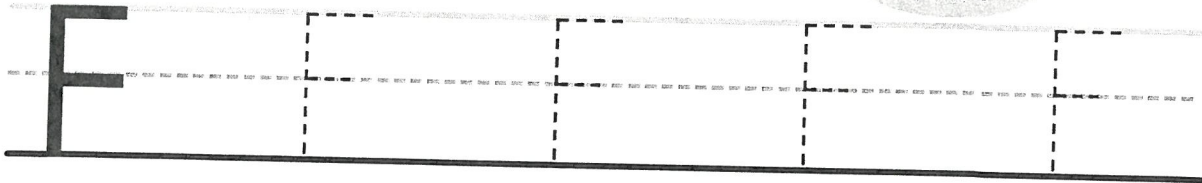

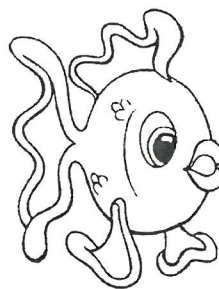
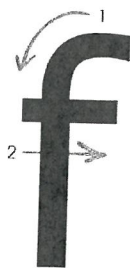
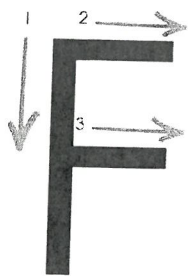

Fish

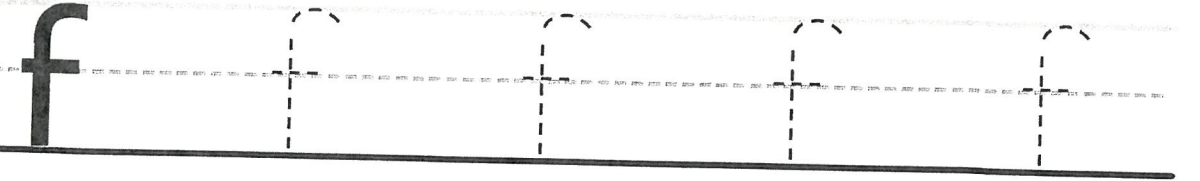
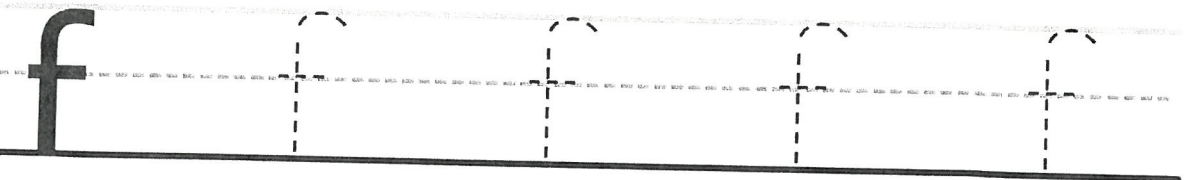
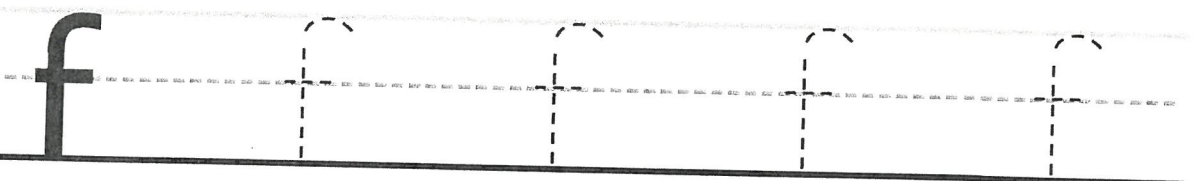
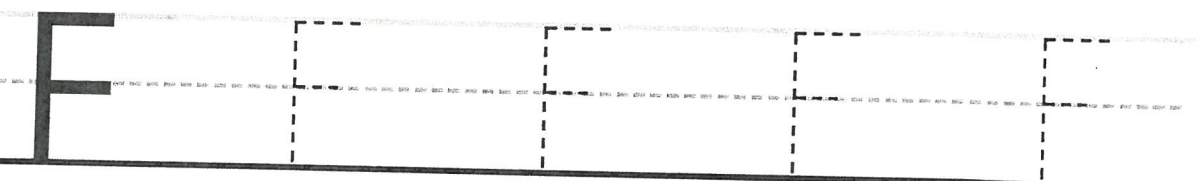
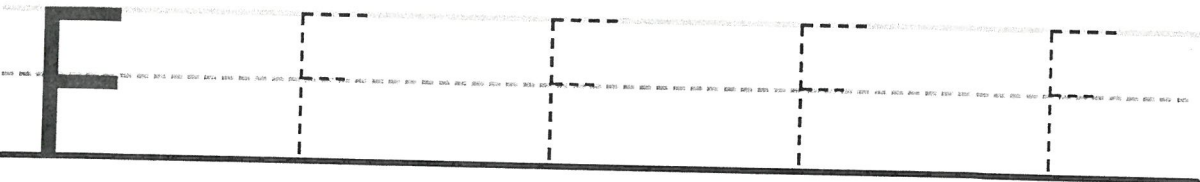
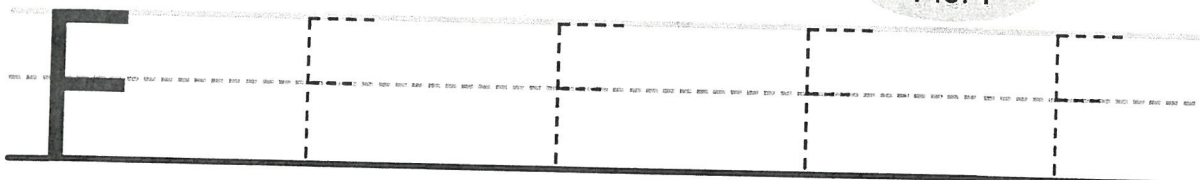

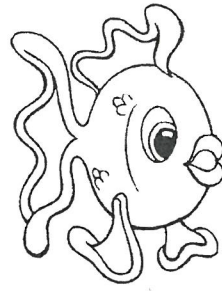
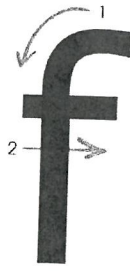
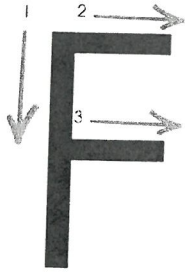

Fish

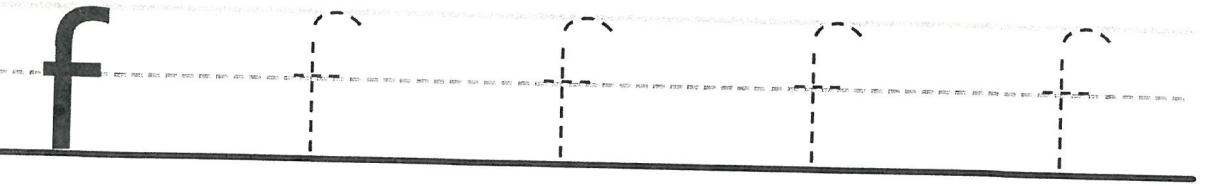
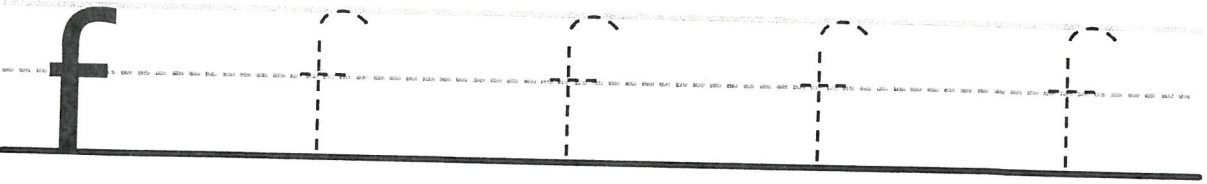
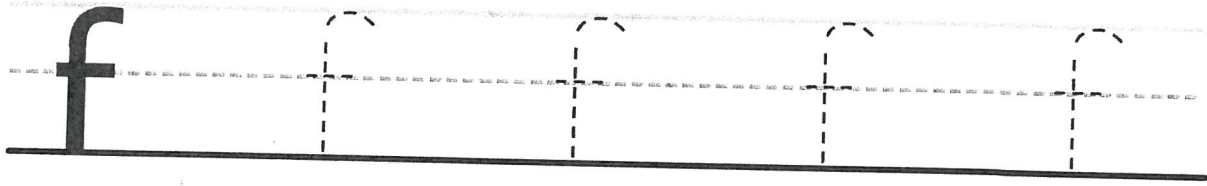
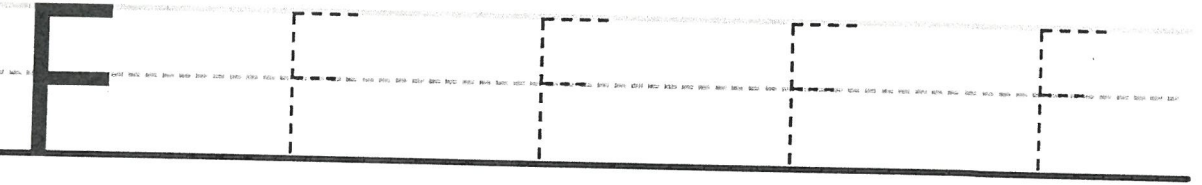
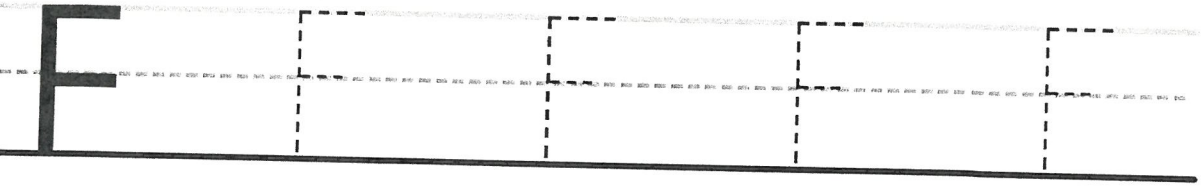
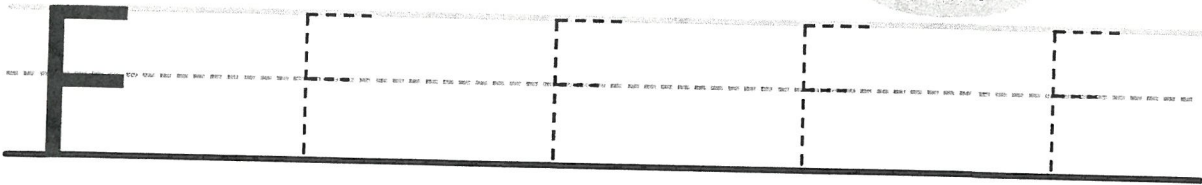

I name:

MATCH THE LETTER









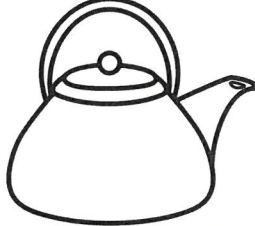

For each row circle the matching letter.

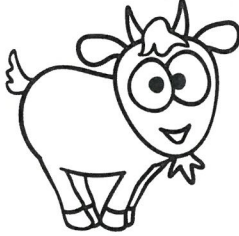
f	o	f	i	k
F	J	Y	F	A
f	f	u	c	h
F	S	B	G	F
f	m	d	a	f
F	K	F	W	P

I name:

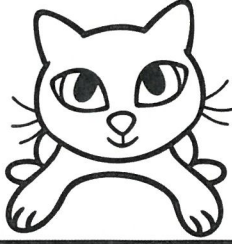
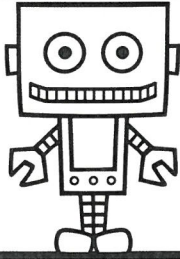
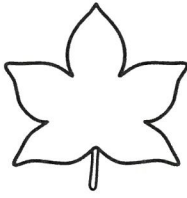
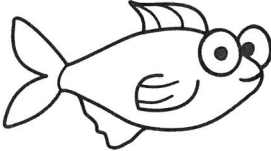
MATCH THE SOUND

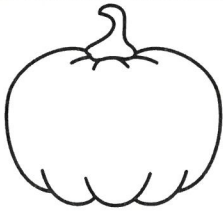
For each row color the picture to match the beginning sound.

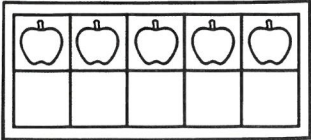
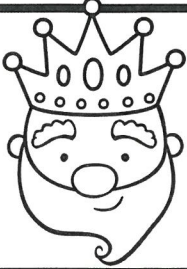
f			
f			
f			
f			
f			
f			

I name:

BUILD LETTER Ff WORDS

Cut and paste the letter f to complete each word.

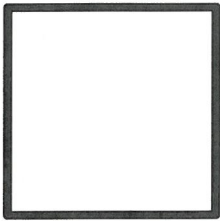
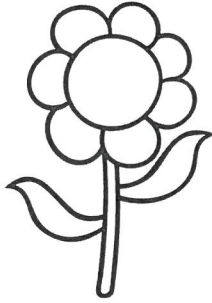

lower

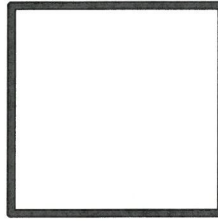

ox

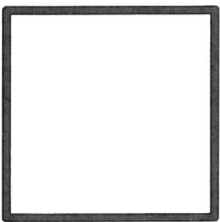

airy

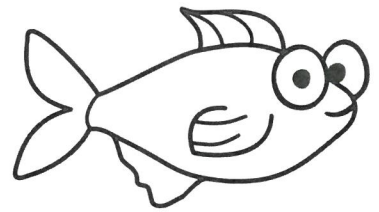

ish

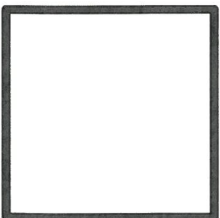
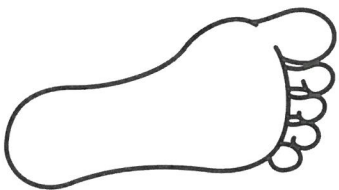

oot

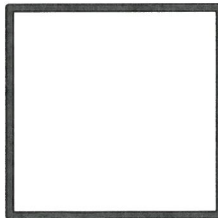
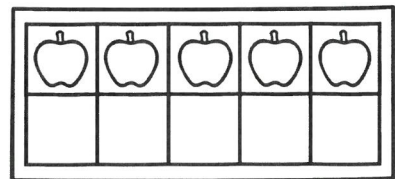

ive

Name _____

Let's warm up!

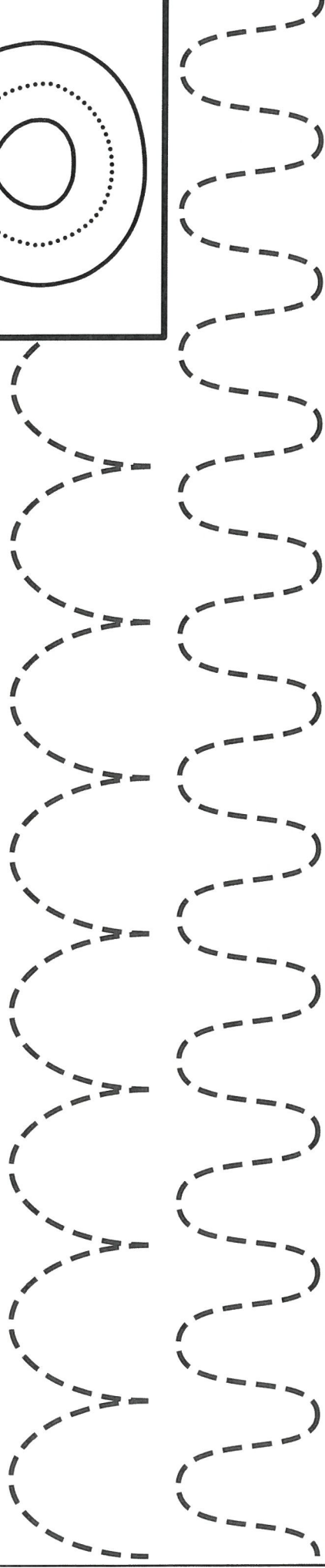

Let's trace the number!

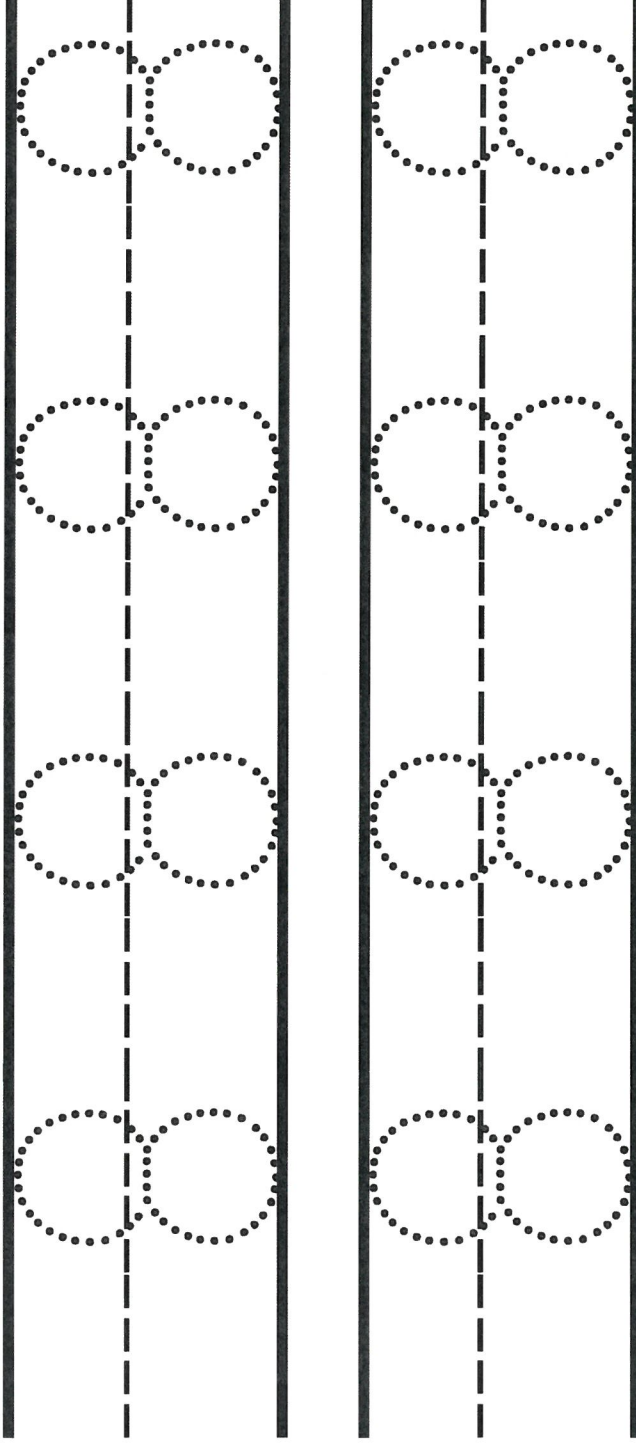

eight holes

Name _____

Let's warm up!

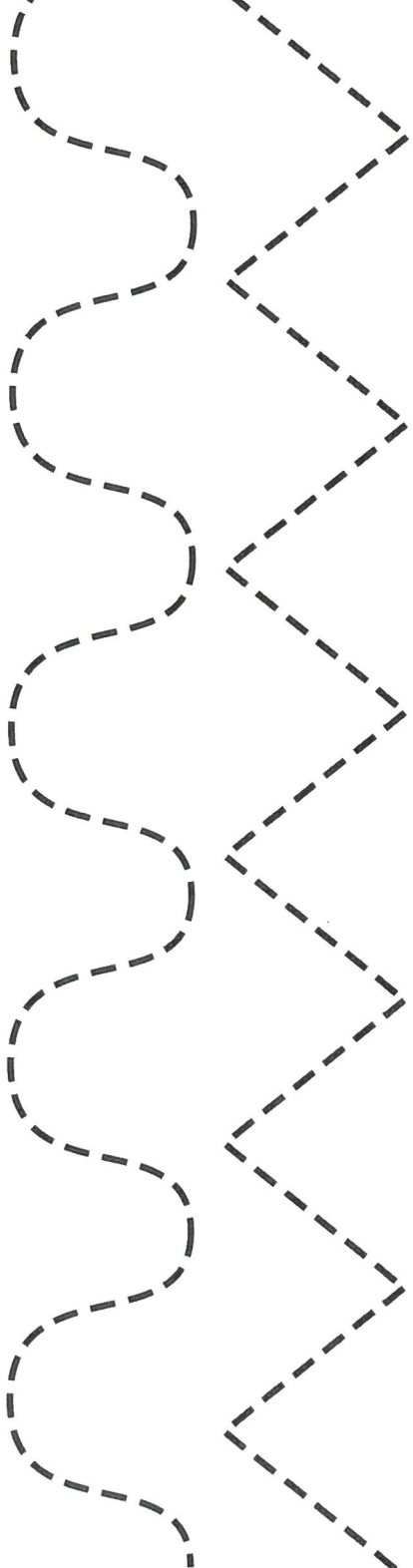

Let's trace the number!

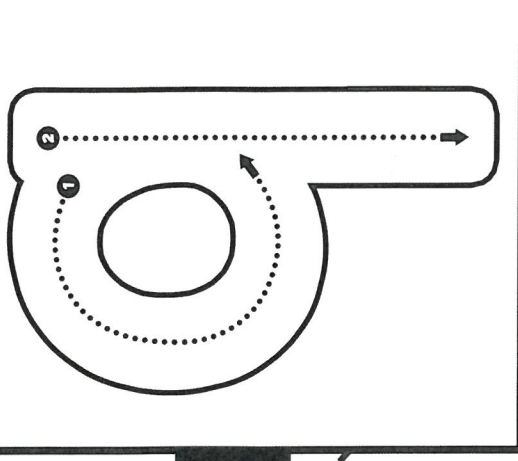
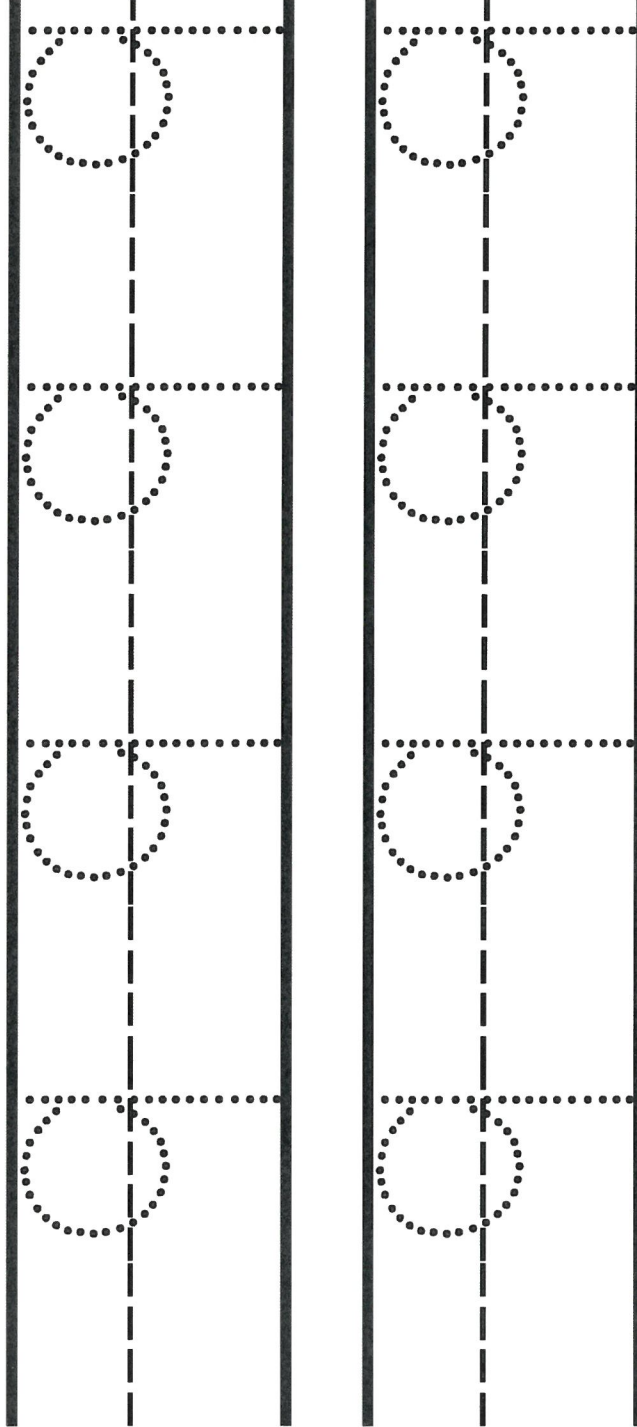

Let's Draw!

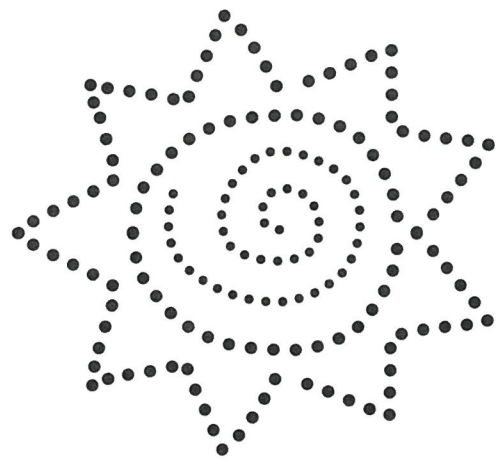

nine rays

Name _____

Let's warm up!

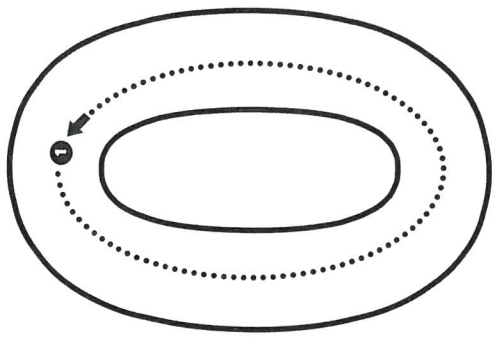
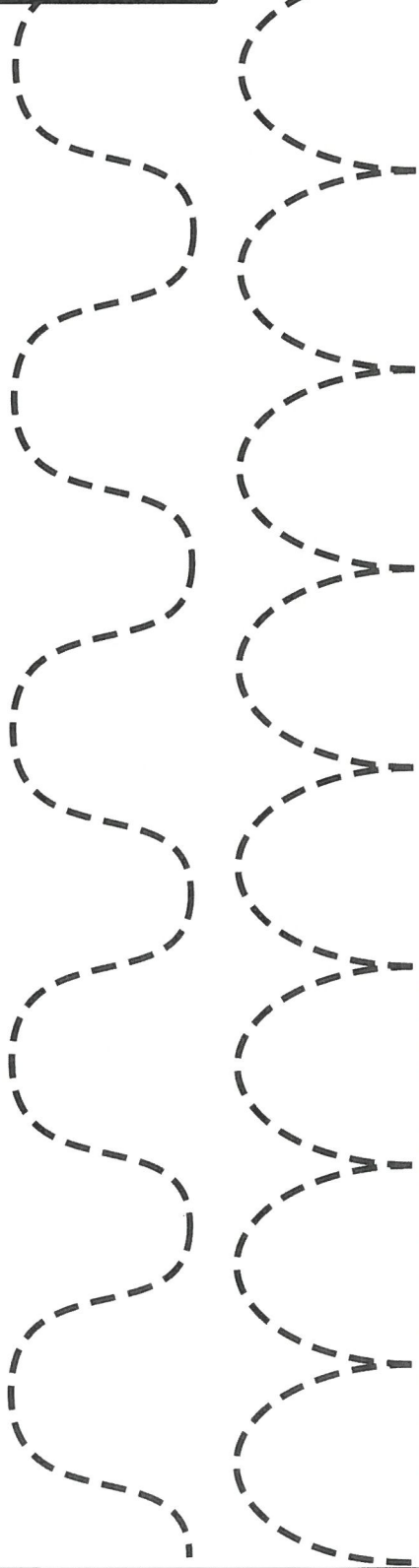

Let's trace the number!

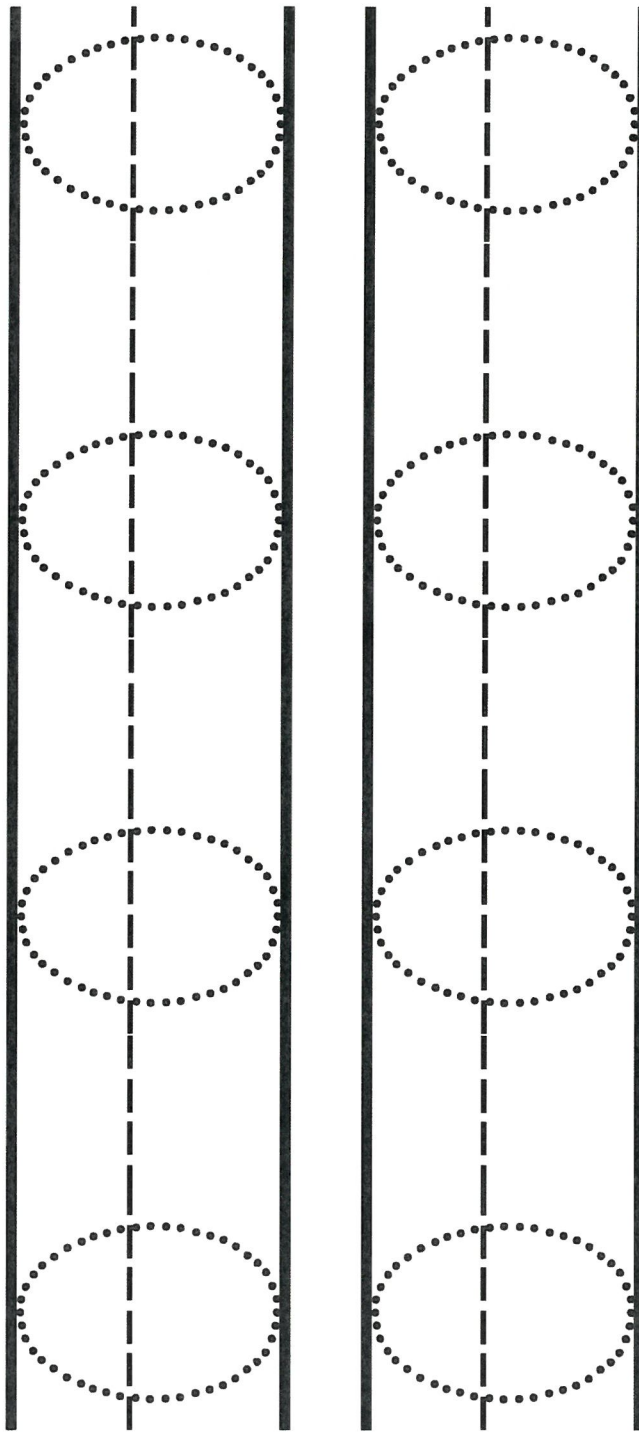

Let's Draw!

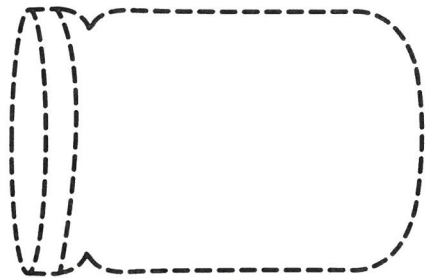

zero
cookies

Find the word that rhymes!

